

BLPG
Programming unit for
light curtain blanking functions

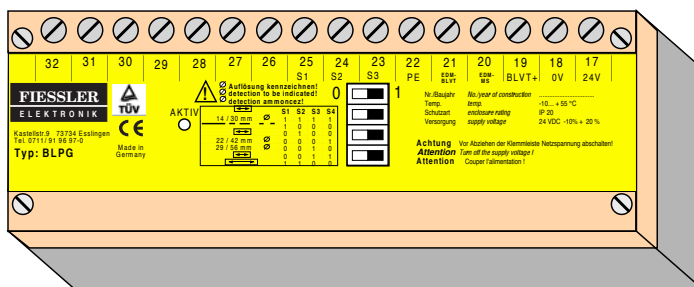

BPSG
Programming unit for
light curtain blanking functions
and switching unit

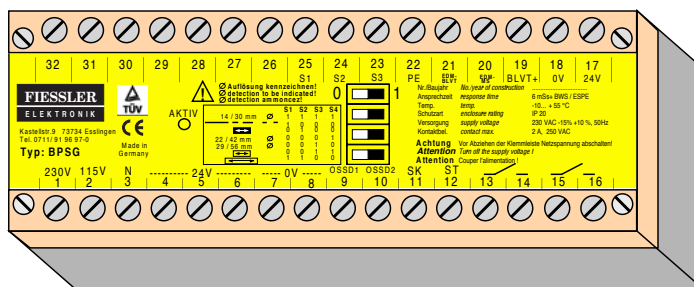

Features:

- storage one of **11 blanking modes** in the light grid BLCT, ILCT, BLVT or ILVT
- **storage up to 5 blanking modes** in the light grid BLCT, ILCT, BLVT or ILVT **and recall via a selector switch again**
- storage **up to 5 operation modes** in the switching units PLSG3 or PLSG3K and recalled with a selector switch again. e.g. cycle control, Muting mode or safety mode (in each case with and without restart interlock, with and without contactor control)
- storage **up to 5 modes of operation** in the switching units PLSG3 or PLSG3K and at the same time can be stored **up to 5 blanking modes** in the light grids BLCT, ILCT, BLVT or ILVT **and recall via a selector switch again**



CONTENTS:

Safety instructions



Application notes

Electric connection

Technical specifications

**For over 50 years,
we have specialized in the area of
opto-electronics.**

Our experience is your gain.

**Tell us your problems and we will
be pleased to advise you.**



Footmats

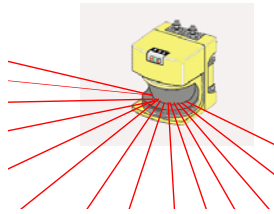

Laser scanners

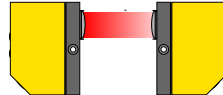

Single-beam safety light
barriers with a long range
(up to 150 m)

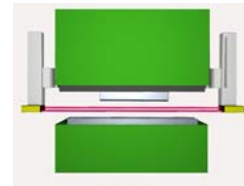

Press brake protection system
AKAS®

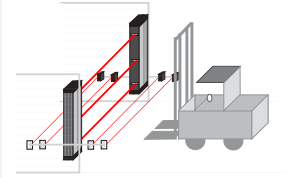

Differentiation between
humans and machines by
muting function

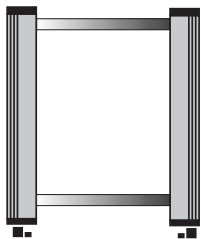

Two-beam light grids with a
range of up to 60 m

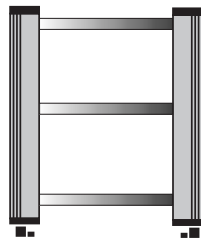

Three- or more beam light grids
with a range of up to 60 m



Two-beam light grids with
transmitter / receiver units
and a deflecting mirror with a
range of up to 10 m

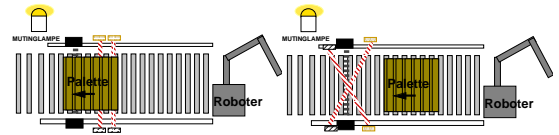

Output muting: Differentiation
between humans and material

Cross-muting: Differentiation
between humans and material
/ machines

Fiessler Elektronik GmbH & Co. KG
Kastellstr. 9
D-73734 Esslingen

Phone: +49(0)711-91 96 97-0
Fax: +49(0)711-91 96 97-50
Email: info@fiessler.de
Internet: www.fiessler.de

Represented in all major importing



We also invest in environmental safety

Chapter	Contents	Page
1.	Programming process (without selector switch)	4
2.	Electrical connection	5
	Connections with the Light curtain BLCT / ILCT	
2.1	Connection of BLPG with restart interlock / with contactor control (EDM)	5
2.2	Connection of BLPG without restart interlock / without control of subsequent switching elements	5
2.3	Connection of BLPG with restart interlock / without control of subsequent switching elements...	6
2.4	Connection of BLPG without restart interlock / with contactor control (EDM)	6
2.5	Connection of BPSG with restart interlock / with contactor control (EDM)	7
2.6	Connection of BPSG without restart interlock / without control of subsequent switching elements	8
	Connections with the Light curtain BLVT / ILVT	
2.7	Connection of BLPG with restart interlock / with contactor control (EDM)	9
2.8	Connection of BLPG without restart interlock / without control of subsequent switching elements	9
2.9	Connection of BLPG with restart interlock / without control of subsequent switching elements...	10
2.10	Connection of BLPG without restart interlock / with contactor control (EDM)	10
2.11	Connection of BPSG with restart interlock / with contactor control (EDM)	11
2.12	Connection of BPSG without restart interlock / without control of subsequent switching elements	12
3.	Operation with a Selector switch	13
3.1	Connection of a selector switch to BLPG / BPSG	13
3.2	Storage and recall of up to 5 blanking modes in the light curtain	14
	Connection of PLSG-switching unit see PLSG Operation manual	
4.	Dimensional drawing	16
5.	Technical Datas	17
6.	Safety instructions	18
7.	Service / Maintenance / Warranty	19



1. Programming procedure (also refer to the operating manual of the light curtain)

BLPG: Blanking programming unit

A key switch is used to enable programming. The programming unit is not absolutely necessary for operating the light curtain and can be removed again once programming is complete..

BPSG: Blanking programming unit and switching unit

Like type BLPG, but also with a voltage supply and force-guided relay with potential-free outputs.

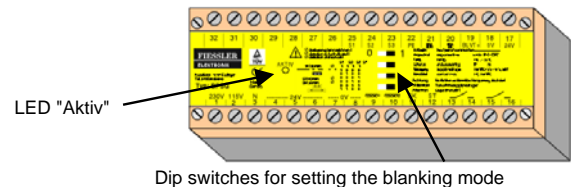
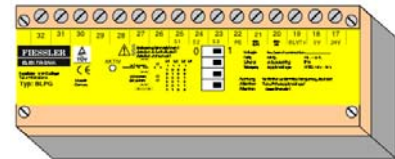

Instruction applies to **BPSG** and **BLPG** units without a selector switch connection (with selector switch connection see Chapter 3)

Programming must only be performed by authorized personnel. The key switch for enabling programming must be removed again immediately after programming is complete. The light curtain's current resolution must be clearly indicated on the accompanying sign.

1. Set the desired blanking mode using the DIP switches (refer to the BLVT operating manual).
2. Install barriers in the protective field. These are blanked after programming. **The first beam (as seen from the plug) must not be dark, as it is needed to synchronize the transmitter and receiver.** If beam 1 is covered during teach-in, the light curtain assumes the error state and the orange and yellow LEDs on the receiver start to flash rapidly (about 4 times per second). The programming process must be repeated with a free first beam.
3. Turn the key switch to the programming setting. Wait until the controller's green LED indicates readiness for programming (about 2 seconds). If the green LED "Aktiv" is flashing, this indicates a wrong switching position of the DIP switches or a wrong connection at the selector switch connection terminals.
4. Remove the key switch. Programming is complete once the green LED " is deactivated. On the Display of BLCT/ILCT appears about 2sec. the blanking mode (see also Table).
5. Test the protective field with an appropriate rod. At any point in the field, this rod must deactivate the outputs. If the blanked areas do not cover the entire protective field, additional protective grids need to be installed.
6. Affix a sign indicating the current resolution.
7. The light curtain is now ready for operation. The dynamic blanking and reduced resolution operating modes are indicated by slow flashing (about once per second) of the adjustment aid and restart interlock LEDs on the receiver (with the protective field clear).

Blanking modes:	Dip switch				only BLCT / ILCT
	S1	S2	S3	S4	Display:
No blanking	1	1	1	1	AA
Static blanking	1	0	0	0	CC
Static blanking with 1-beam reduced resolution	1	0	0	1	C1
Static blanking with 2-beam reduced resolution	1	0	1	0	C2
Dynamic blanking (only 1 area possible)	0	1	0	0	HH
Dynamic blanking with 1-beam reduced resolution	0	1	0	1	H1
Dynamic blanking with 2-beam reduced resolution	0	1	1	0	H2
1-beam reduced resolution	0	0	0	1	1r
2-beam reduced resolution	0	0	1	0	2r
Ignore 1 beam only once (full resolution for the remaining protective field)	0	0	1	1	1u
Ignore 2 beams only once (full resolution for the remaining protective field)	1	1	0	0	1u

Important notes and restrictions are provided in the light curtain operating manual.

2.1 Connection with restart interlock /with contactor control (EDM)

BLCT / ILCT-receiver:

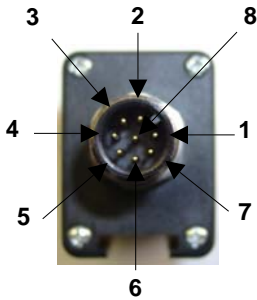

- 1 / white: Start
- 2 / brown: +UB
- 4 / yellow: EDM
- 5 / grey: OSSD1
- 6 / pink: OSSD2
- 7 / blue: -UB

Operation mode of BLCT/ILCT:
- with contactor control
- with restart interlock

Display during power on:

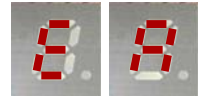

If the protective field is interrupted, the NO-contacts of K1 and K2 open and the movement is interrupted.

Only If both contactors / valves K1 and K2 are switched off and the protective field is clear again, a new duty cycle or movement is possible by actuating the start button.

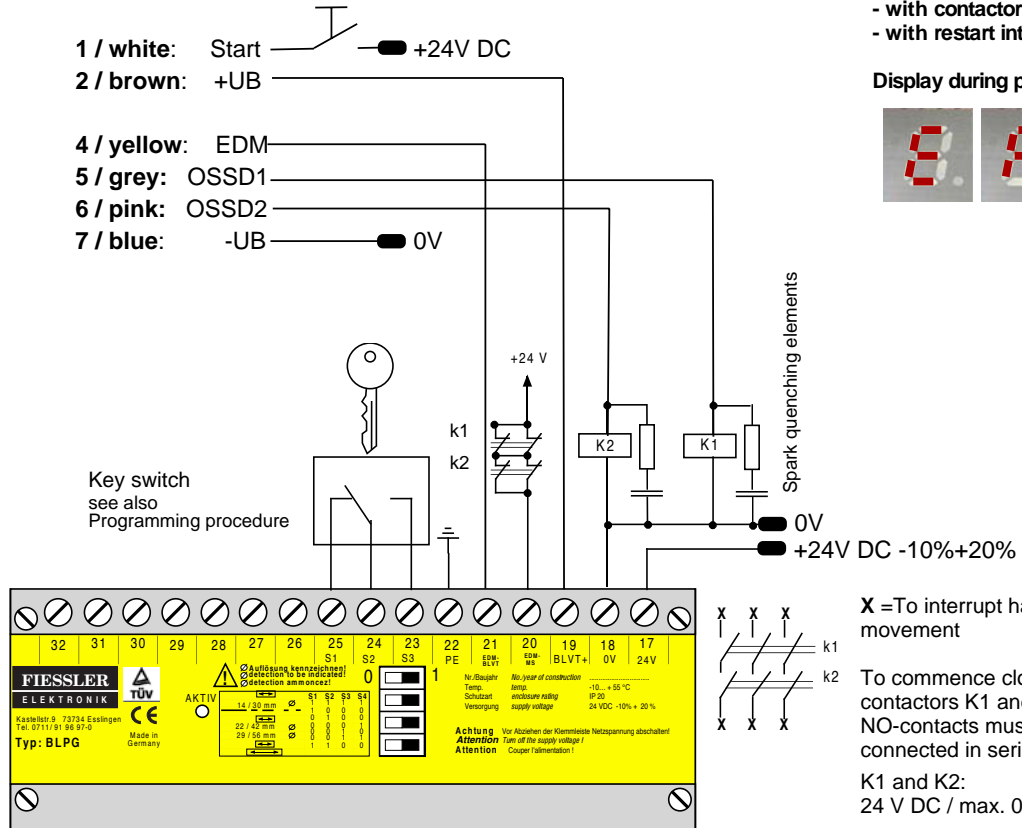

X = To interrupt hazardous movement

To commence closure by contactors K1 and K2, their NO-contacts must be connected in series.

K1 and K2:
24 V DC / max. 0.5 A

2.2 Connection without restart interlock / without EDM (without control of subsequent switching elements)

BLCT / ILCT-receiver:

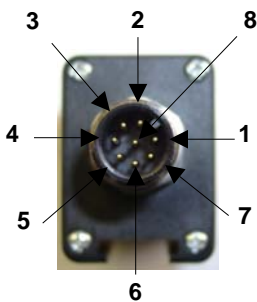

- 1 / white: Start
- 2 / brown: +UB
- 4 / yellow: EDM
- 5 / grey: OSSD1
- 6 / pink: OSSD2
- 7 / blue: -UB

Operation mode of BLCT/ILCT:
- without contactor control
- without restart interlock

Display during power on:

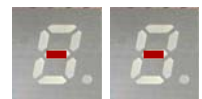

If the protective field is interrupted, the outputs OSSD1 and OSSD2 open and the movement is interrupted by the follow-up safety control.

A new duty cycle or movement is only possible if the protective field is clear again.

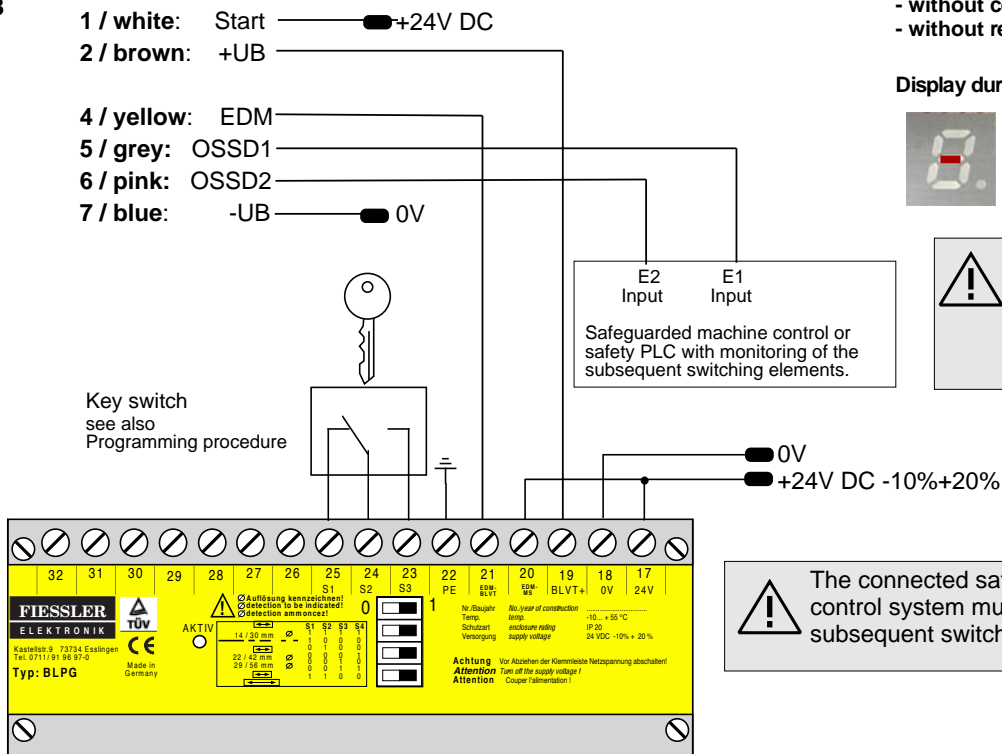

! A restart interlock must be provided for passable areas.

! The connected safeguarded control system must monitor the subsequent switching elements.

2.3 Connection with restart interlock / without EDM (without control of subsequent switching elements)

BLCT / ILCT-receiver:

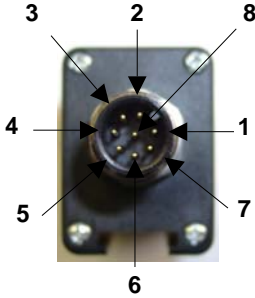

- 1 / white: Start
- 2 / brown: +UB
- 4 / yellow: EDM
- 5 / grey: OSSD1
- 6 / pink: OSSD2
- 7 / blue: -UB

If the protective field is interrupted, the outputs OSSD1 and OSSD2 open and the movement is interrupted by the follow-up safety control.

Only If the protective field is clear again, a new duty cycle or movement is possible by actuating the start button.

Key switch
see also
Programming procedure

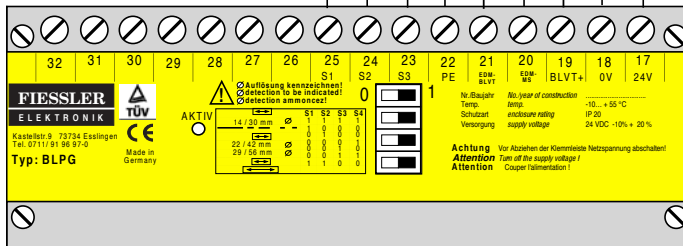

Operation mode of BLCT/ILCT:
- without contactor control
- with restart interlock

Display during power on:

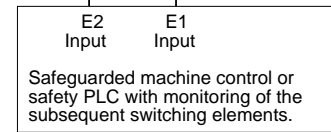
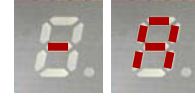

The connected safeguarded control system must monitor the subsequent switching elements.

2.4 Connection without restart interlock / with contactor control (EDM)

BLCT / ILCT-receiver:

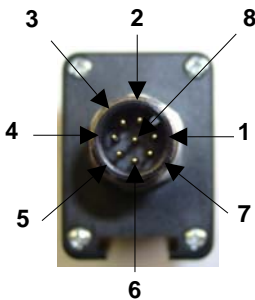

- 1 / white: Start
- 2 / brown: +UB
- 4 / yellow: EDM
- 5 / grey: OSSD1
- 6 / pink: OSSD2
- 7 / blue: -UB

If the protective field is interrupted, the NO-contacts of K1 and K2 open and the movement is interrupted.

Only If both contactors / valves K1 and K2 are switched off and the protective field is clear again, a new duty cycle or movement is possible.

Key switch
see also
Programming procedure

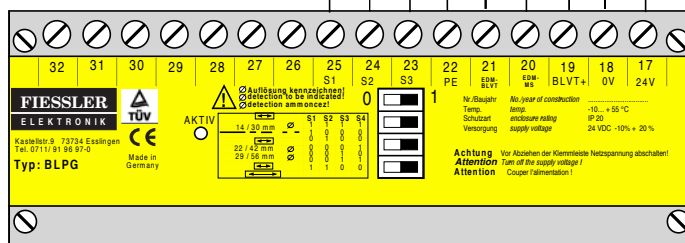

Operation mode of BLCT/ILCT:
- with contactor control
- without restart interlock

Display during power on:

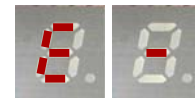

A restart interlock must be provided for passable areas.

Spark quenching elements

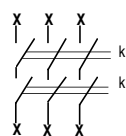

X = To interrupt hazardous movement

To commence closure by contactors K1 and K2, their NO-contacts must be connected in series.

K1 and K2:
24 V DC / max. 0.5 A

The BPSG controller fulfils the power-failure bridging standard of 20 ms specified by EN 60204 and is therefore suitable for supplying the BLCT / ILCT light curtain with voltage.

2.5 Connection with restart interlock /with contactor control (EDM)

BLCT / ILCT-receiver:

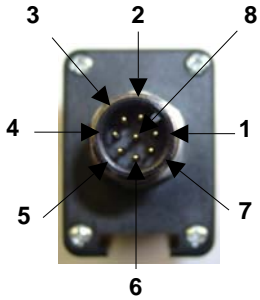

- 1 / white: Start
- 2 / brown: +UB
- 4 / yellow: EDM
- 5 / grey: OSSD1
- 6 / pink: OSSD2
- 7 / blue: -UB

Terminal 12

Terminal 9

Terminal 10

Key switch
see also
Programming procedure

Operation mode of BLCT/ILCT:
- with contactor control
- with restart interlock

Display during power on:



Connection variant 1: External contactors control hazardous movement.

If the protective field is clear and the start button is operated, the potential-free output contacts 13-14 and 15-16 close, and connected contactors K1 and K2 switch on.

Terminal 2 (EDM) on the light curtain can be used to control the contactors or hydraulic valves K1 and K2 which initiate the hazardous movement. (control path: terminals 4 and 20 on the controller)

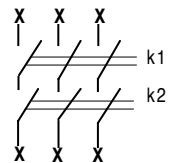
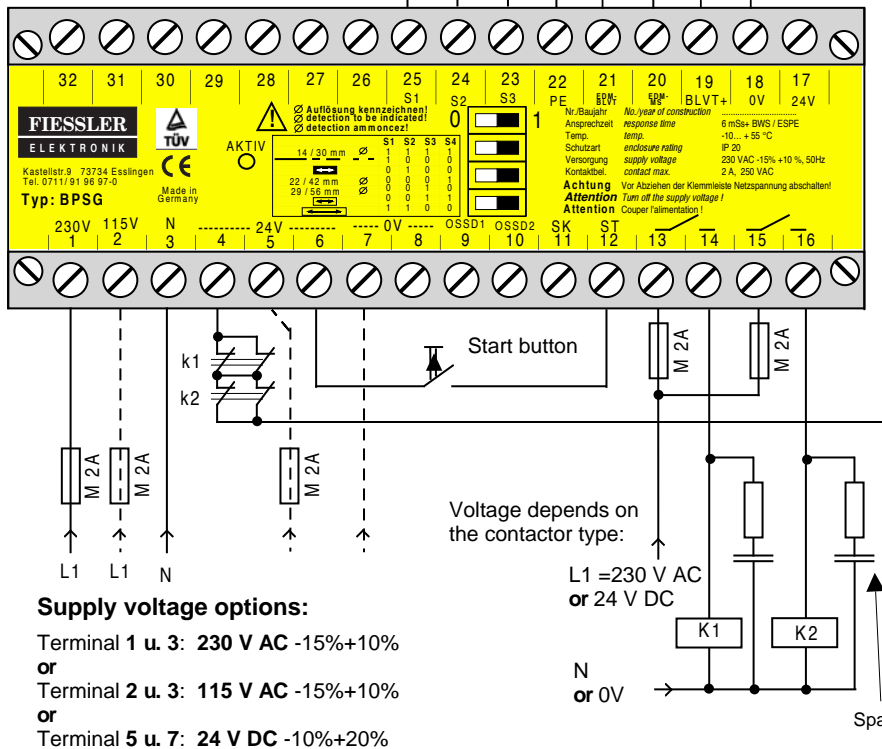

X = To interrupt hazardous movement

To commence closure by contactors K1 and K2, their NO-contacts must be connected in series.

a) Connection variant 1

If the protective field is interrupted, the NO-contacts of K1 and K2 open and the movement is interrupted. Only if both contactors / valves K1 and K2 are switched off and the protective field is clear again, a new duty cycle or movement is possible by actuating the start button.

b) Connection variant 2

If the protective field is interrupted, the internal safety relays open and the movement is interrupted. Only if both internal safety relays are switched off and the protective field is clear again, a new duty cycle or movement is possible by actuating the start button.

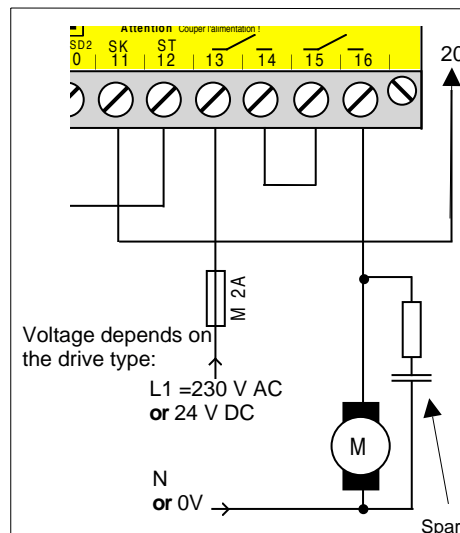

Connection variant 2:

(Maximum load 2 A/250 VAC or 60 VDC, 30W)

The internal safety relays control hazardous movement.

If the protective field is clear and the start button is operated, the potential-free output contacts 13-14 and 15-16 close, and hazardous movement is start.

Terminal 2 (EDM) on the light curtain can be used to additionally control the internal switching elements (13 - 14 and 15 - 16) which initiate hazardous movement. **Terminal 11 and 20 must be bridged.**

Connection with safety follow-up circuit (with potentialfree contacts)

2.6 Connection without restart interlock / without control of the follow-up circuit

The BPSG controller fulfils the power-failure bridging standard of 20 ms specified by EN 60204 and is therefore suitable for supplying the BLCT / ILCT light curtain with voltage.

BLCT / ILCT-receiver:

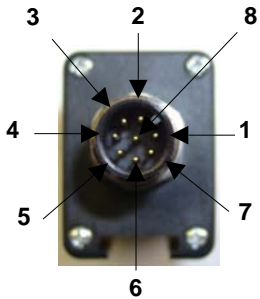

- 1 / white: Start
- 2 / brown: +UB
- 4 / yellow: EDM
- 5 / grey: OSSD1
- 6 / pink: OSSD2
- 7 / blue: -UB

Operation mode of BLCT/ILCT:
 - with contactor control
 - without restart interlock

Display during power on:

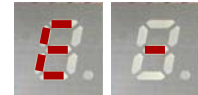

Key switch
 see also
 Programming procedure

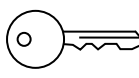

If the protective field is interrupted, the internal safety relays open and the movement is interrupted by the follow-up safety control.

Only If both internal safety relays are switched off and the protective field is clear again, a new duty cycle or movement is possible.

A restart interlock must be provided for passable areas.

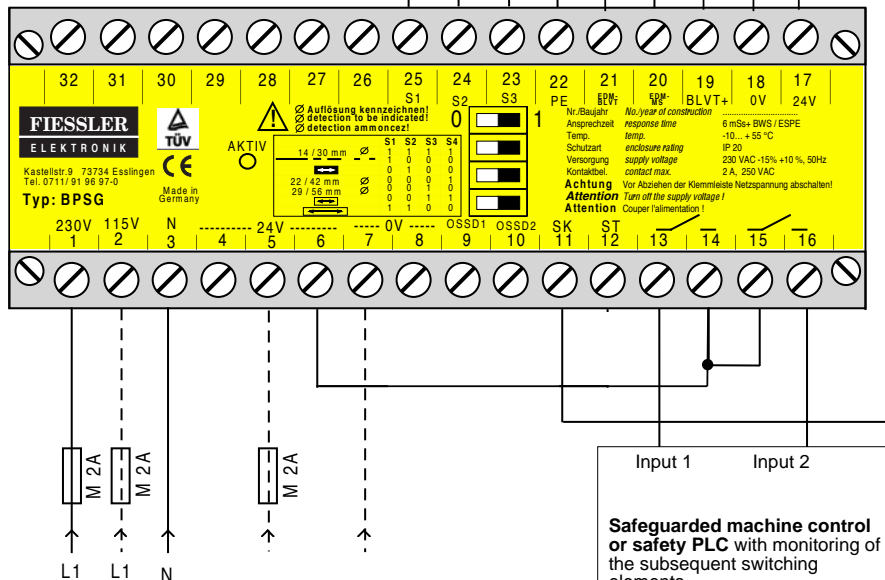

Supply voltage options:

- Terminal 1 u. 3: 230 V AC -15%+10%
- or
- Terminal 2 u. 3: 115 V AC -15%+10%
- or
- Terminal 5 u. 7: 24 V DC -10%+20%

Input 1 Input 2

Safeguarded machine control or safety PLC with monitoring of the subsequent switching elements.

If necessary, restart interlock must be realized.

The connected safeguarded control system must monitor the subsequent switching elements.

2.7 Connection with restart interlock /with contactor control (EDM)

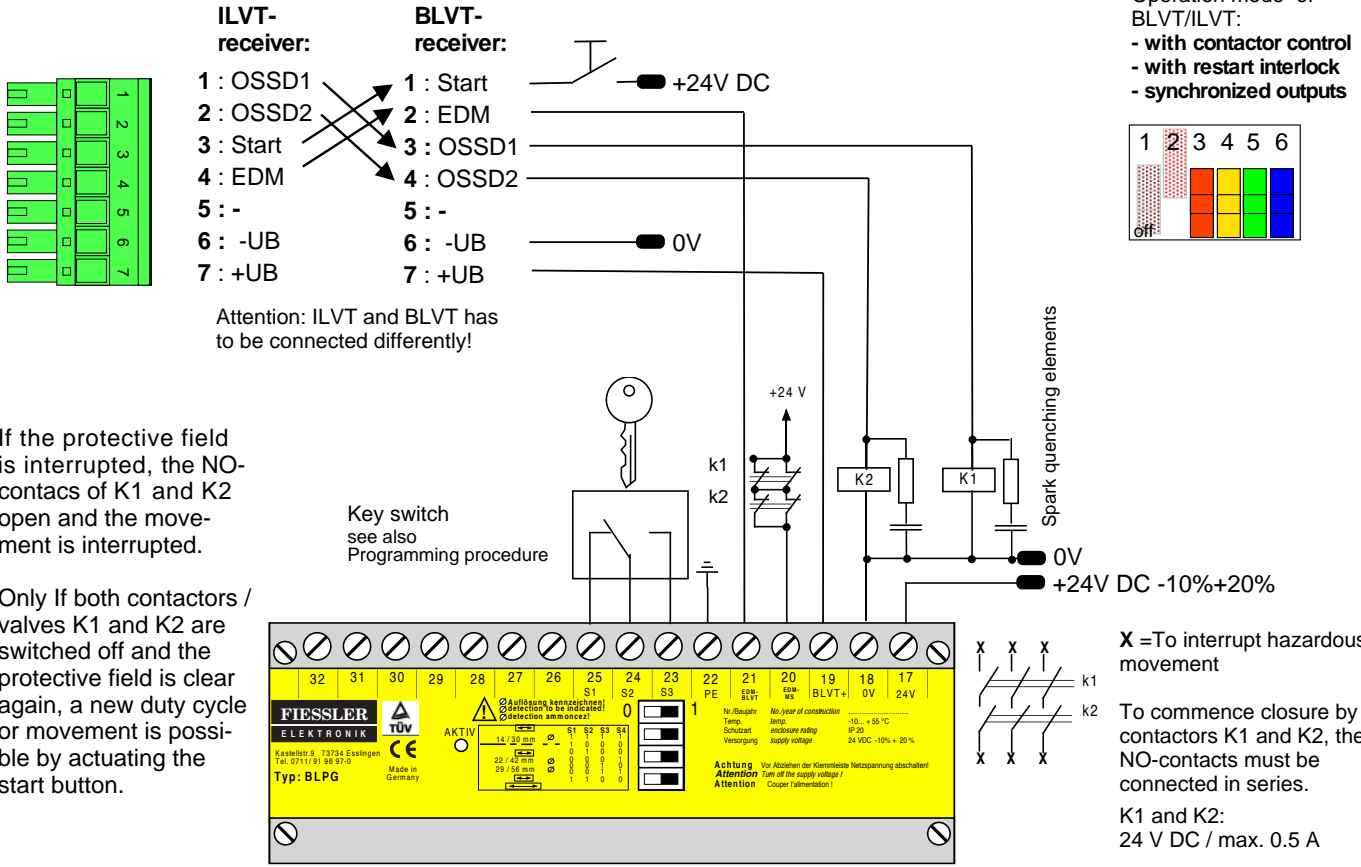

2.8 Connection without restart interlock / without EDM (without control of subsequent switching elements)

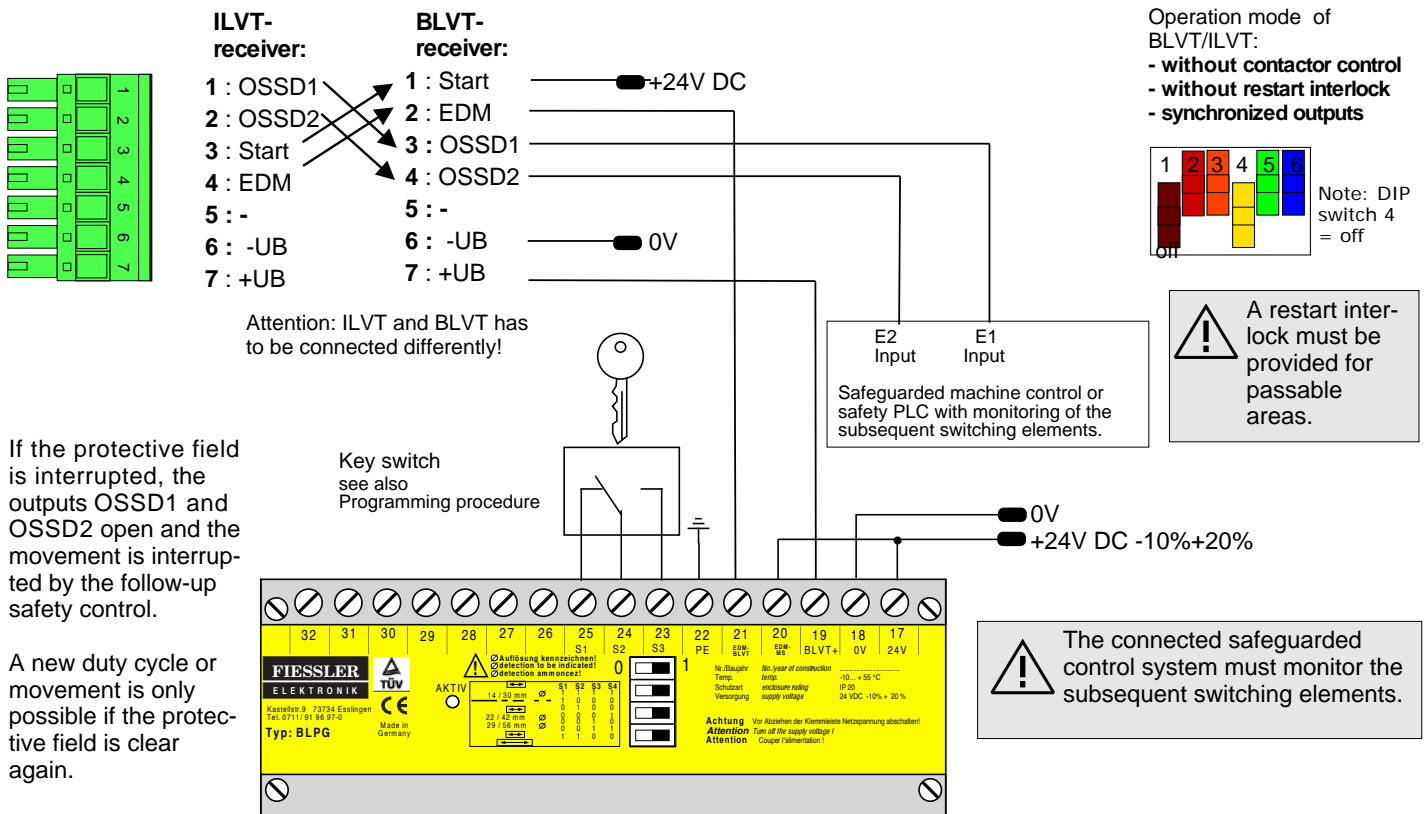

2.9 Connection with restart interlock / without EDM (without control of subsequent switching elements)

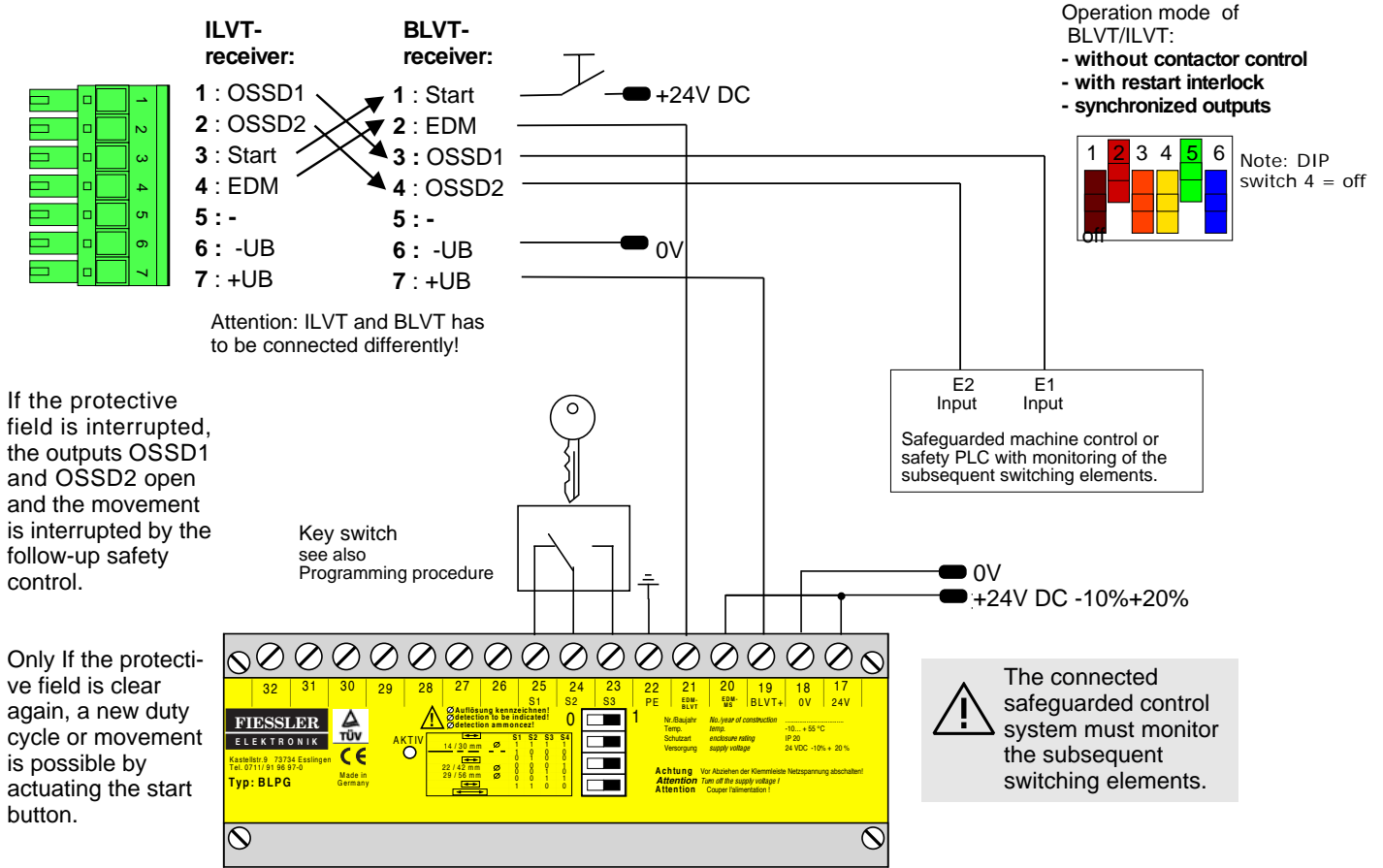

2.10 Connection without restart interlock / with contactor control (EDM)

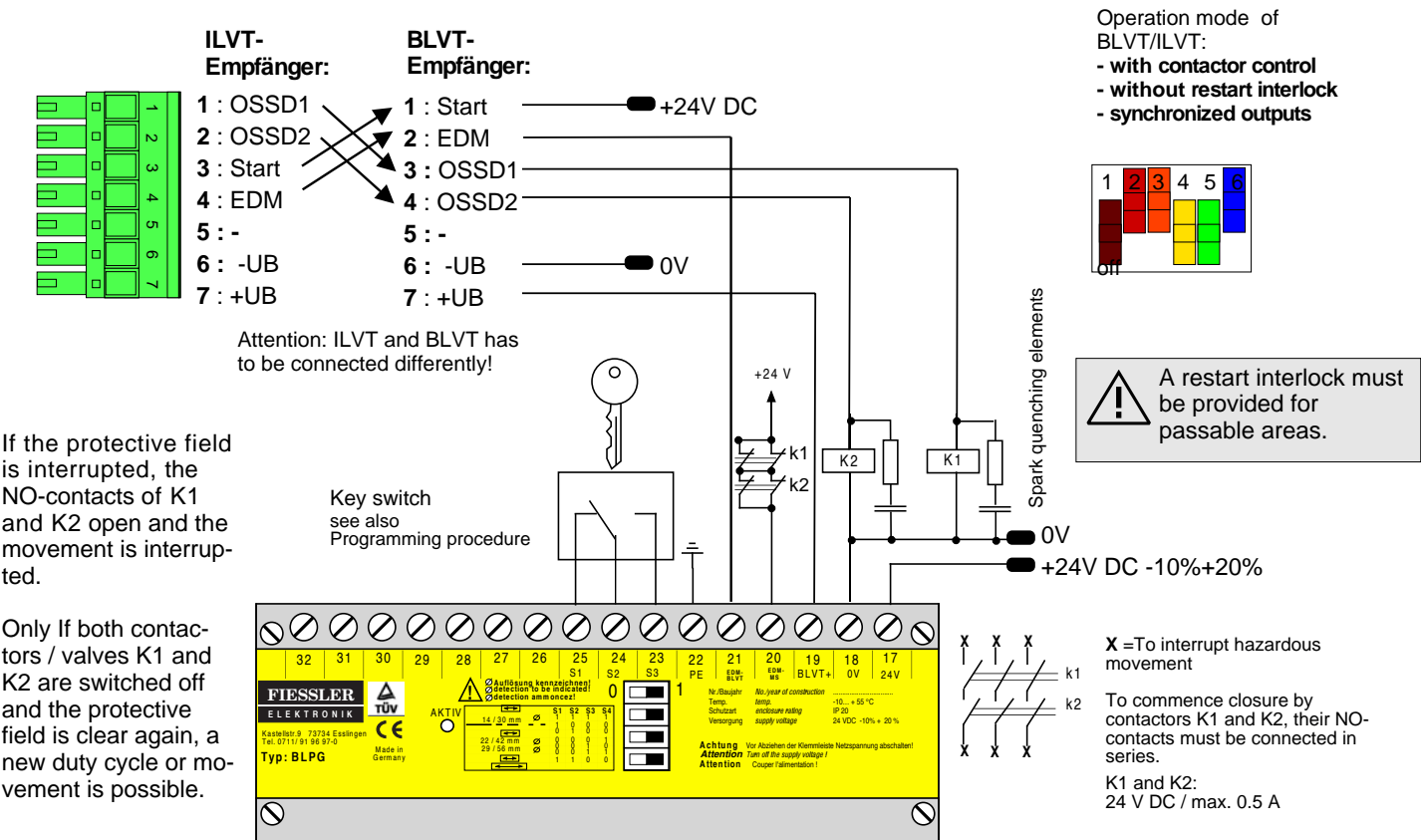

The BPSG controller fulfils the power-failure bridging standard of 20 ms specified by EN 60204 and is therefore suitable for supplying the BLVT / ILVT light curtain with voltage.

2.11 Connection with restart interlock /with contactor control (EDM)

Operation mode of BLVT/ILVT:
 - with contactor control
 - with restart interlock
 - synchronized outputs

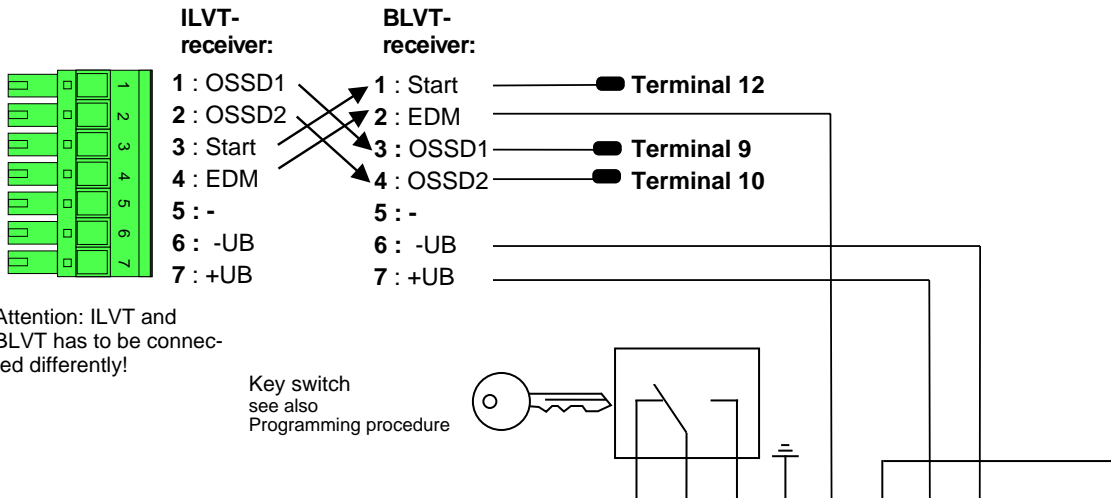

Attention: ILVT and BLVT has to be connected differently!

Key switch see also Programming procedure

Connection variant 1: External contactors control hazardous movement.

If the protective field is clear and the start button is operated, the potential-free output contacts 13-14 and 15-16 close, and connected contactors K1 and K2 switch on.

Terminal 2 (EDM) on the light curtain can be used to control the contactors or hydraulic valves K1 and K2 which initiate the hazardous movement. (control path: terminals 4 and 20 on the controller)

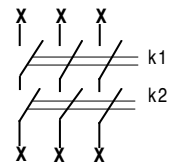
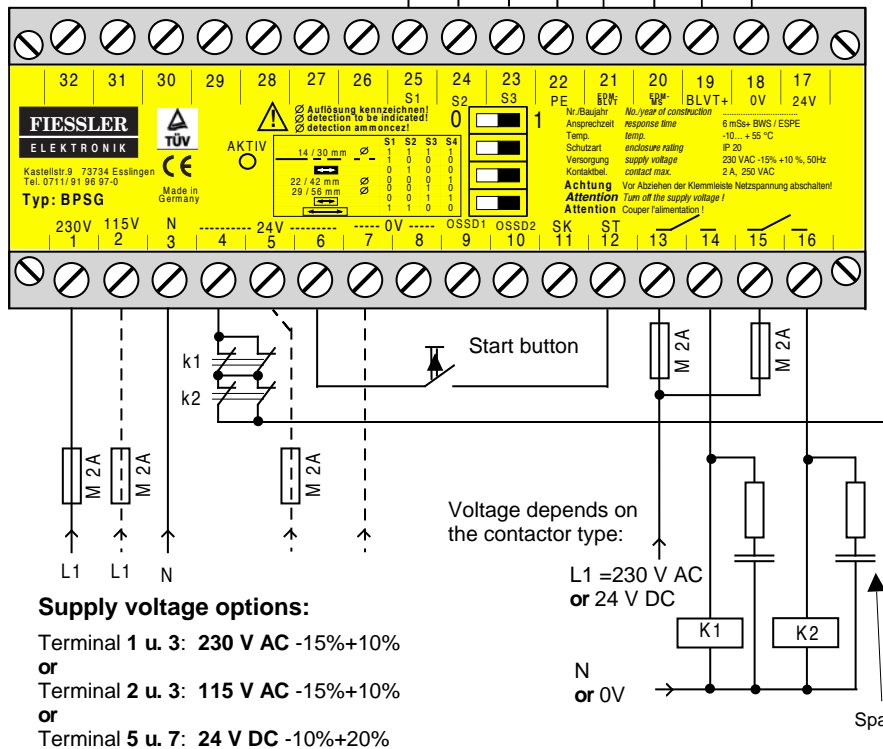

X = To interrupt hazardous movement

To commence closure by contactors K1 and K2, their NO-contacts must be connected in series.

a) Connection variant 1

If the protective field is interrupted, the NO-contacts of K1 and K2 open and the movement is interrupted.

Only If both contactors / valves K1 and K2 are switched off and the protective field is clear again, a new duty cycle or movement is possible by actuating the start button.

b) Connection variant 2

If the protective field is interrupted, the internal safety relays open and the movement is interrupted.

Only If both internal safety relays are switched off and the protective field is clear again, a new duty cycle or movement is possible by actuating the start button.

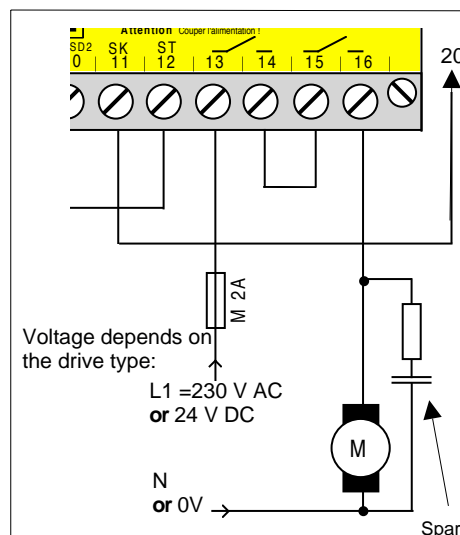

Connection variant 2:

(Maximum load 2 A/250 VAC or 60 VDC, 30W)

The internal safety relays control hazardous movement.

If the protective field is clear and the start button is operated, the potential-free output contacts 13-14 and 15-16 close, and hazardous movement is start.

Terminal 2 (EDM) on the light curtain can be used to additionally control the internal switching elements (13 - 14 and 15 - 16) which initiate hazardous movement. **Terminal 11 and 20 must be bridged.**

Connection with safety follow-up circuit (with potentialfree contacts)

2.12 Connection without restart interlock / without control of the follow-up circuit

The BPSG controller fulfils the power-failure bridging standard of 20 ms specified by EN 60204 and is therefore suitable for supplying the BLVT / ILVT light curtain with voltage.

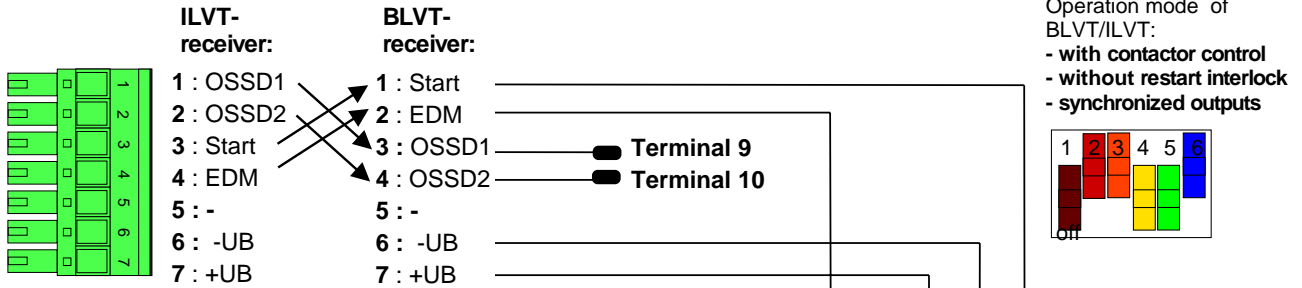

Attention: ILVT and BLVT has to be connected differently!

Key switch see also Programming procedure

If the protective field is interrupted, the internal safety relays open and the movement is interrupted by the follow-up safety control.

Only If both internal safety relays are switched off and the protective field is clear again, a new duty cycle or movement is possible.

! A restart interlock must be provided for passable areas.

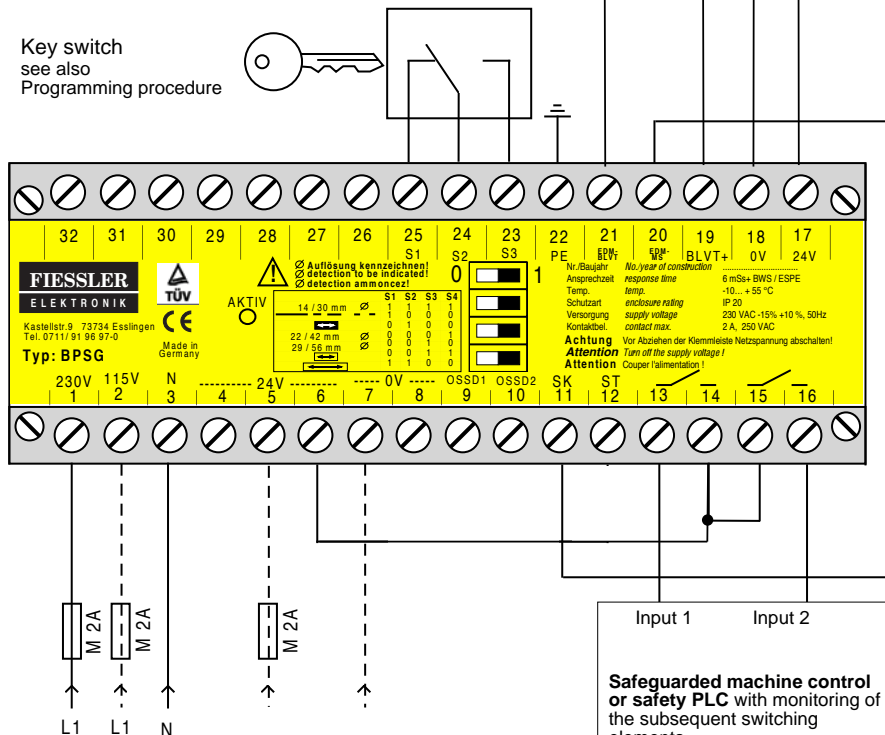

Supply voltage options:

- Terminal 1 u. 3: 230 V AC -15%+10%
- or
- Terminal 2 u. 3: 115 V AC -15%+10%
- or
- Terminal 5 u. 7: 24 V DC -10%+20%

Input 1 Input 2

Safeguarded machine control or safety PLC with monitoring of the subsequent switching elements.

If necessary, restart interlock must be realized.

! The connected safeguarded control system must monitor the subsequent switching elements.

Also refer to the light curtain operating manual

3.1 Connection of a selector switch to the BLPG / BPSG programming unit

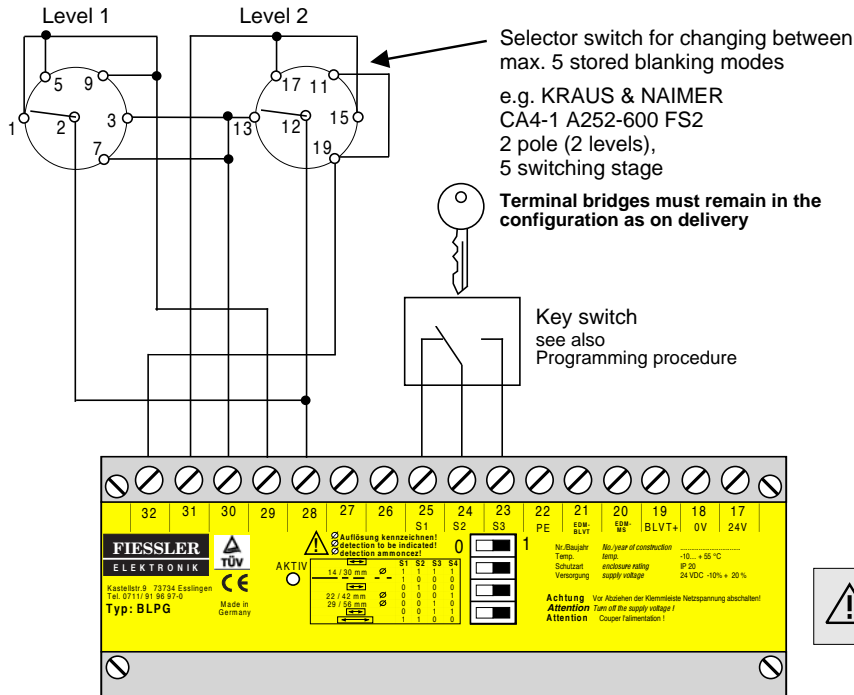

Selector switch	Contact of BLPG/BPSG connected
1	Terminal 28 + 29 + 30
2	Terminal 28 + 29 + 31
3	Terminal 28 + 29 + 32
4	Terminal 28 + 30 + 31
5	Terminal 28 + 30 + 32

Refer to the light curtain operating manual for important notes and constraints.

The light curtain is connected as depicted in the connection diagrams of the previous chapter.

If the green LED "Aktiv" of BLPG / BPSG is flashing, the DIP switches are not set as specified or there is a wrong Connection at Terminal 28 until 32.

Also refer to the light curtain operating manual

3.2 Storage of up to 5 blanking modes in the light curtain and recall via a selector switch

Up to 5 different blanking modes can be stored in the BLCT / ILCT or BLVT / ILVT. With the external selector switch the stored blanking modes can be switchover and recalled.

After switchover or an interruption in the voltage supply, the current blanking mode is retained in the light curtain until the selector switch is moved to a different setting and the key switch is operated again.

Programming must only be performed by authorized personnel. The key switch for enabling programming must be removed again immediately after programming is complete. The light curtain's current resolution must be clearly indicated on the accompanying sign.

Storage of beam blanking:

1. Move the selector switch to the setting to be assigned to the blanking mode requiring teach-in.
2. Use the dip switches to set the required blanking mode.
3. Position the barriers to be blanked in the protective field.
The first beam (as seen from the plug) must not be dark during teach-in. Otherwise the light grid assumes the error state, and the orange and yellow LEDs on the receiver flash rapidly (approximately 4 times / second).
4. Actuate the key switch for at least 2 seconds until the "Active" LED comes on. If the green LED "Aktiv" of BLPG / BPSG is flashing, the DIP switches are not set as specified or there is a wrong Connection at Terminal 28 until 32.
5. Release the key switch.
6. Test the protective field with an appropriate rod. At any point in the field, this rod must deactivate the outputs. If the blanked areas do not cover the entire protective field, additional protective grids need to be installed.
7. The light curtain is now ready for operation. The dynamic blanking and reduced resolution operating modes are indicated by slow flashing (about once per second) of the adjustment aid and restart interlock LEDs on the receiver (with the protective field clear).

blanking modes:	Dip switches				only BLCT/ILCT
	S1	S2	S3	S4	Display:
No blanking	1	1	1	1	A A
Static blanking	1	0	0	0	C C
Static blanking with 1-beam reduced resolution	1	0	0	1	C 1
Static blanking with 1-beam reduced resolution	1	0	1	0	C 2
Dynamic blanking	0	1	0	0	H H
Dynamic blanking with 1-beam reduced resolution	0	1	0	1	H 1
Dynamic blanking with 2-beam reduced resolution	0	1	1	0	H 2
1-beam reduced resolution	0	0	0	1	1 r
2-beam reduced resolution	0	0	1	0	2 r
Only ignore 1 beam once	0	0	1	1	1 u
Only ignore 2 beam once	1	1	0	0	1 u

Repeat steps 1 - 8 for each required selector switch setting.

Example: see next page

Preparing for switching between blanking modes:

(the Dipschalter remains on this position)

1. Set all dip switches to 0

Switching between stored blanking modes:

1. Move the selector switch to the setting assigned to the required operating mode.
2. Actuate the key switch for at least 2 seconds until the "Active" LED comes on.
3. Release the key switch

 After re-programming or switching, the protective field must be tested with a test rod as indicated in operating manual of the light curtain
At any point in the remaining protective field, this rod must lead to deactivation.

 Refer to the light curtain operating manual for important notes and constraints.

3.2 Storage of up to 5 blanking modes in the light curtain and recall via a selector switch

Example:

1. Storage of beam blanking:

Dip switch S1 S2 S3 S4	selector switch	key switch
1 0 0 1 Static blanking with 1-beam reduced resolution	1	actuate for 2 sec.
1 0 1 0 Static blanking with 2-beam reduced resolution	2	actuate for 2 sec.
1 1 0 0 Only ignore 2 beam once	3	actuate for 2 sec.
0 0 1 1 Only ignore 1 beam once	4	actuate for 2 sec.
1 0 0 0 Static blanking	5	actuate for 2 sec.

2. Preparing for switching between blanking modes:

Dip switch S1 S2 S3 S4
0 0 0 0

3. Switching between stored blanking modes:

selector switch	key switch	blanking mode
1	actuate for 2 sec.	Static blanking with 1-beam reduced resolution
2	actuate for 2 sec.	Static blanking with 2-beam reduced resolution
3	actuate for 2 sec.	Only ignore 2 beam once
4	actuate for 2 sec.	Only ignore 1 beam once
5	actuate for 2 sec.	Static blanking

4. Dimensional drawings

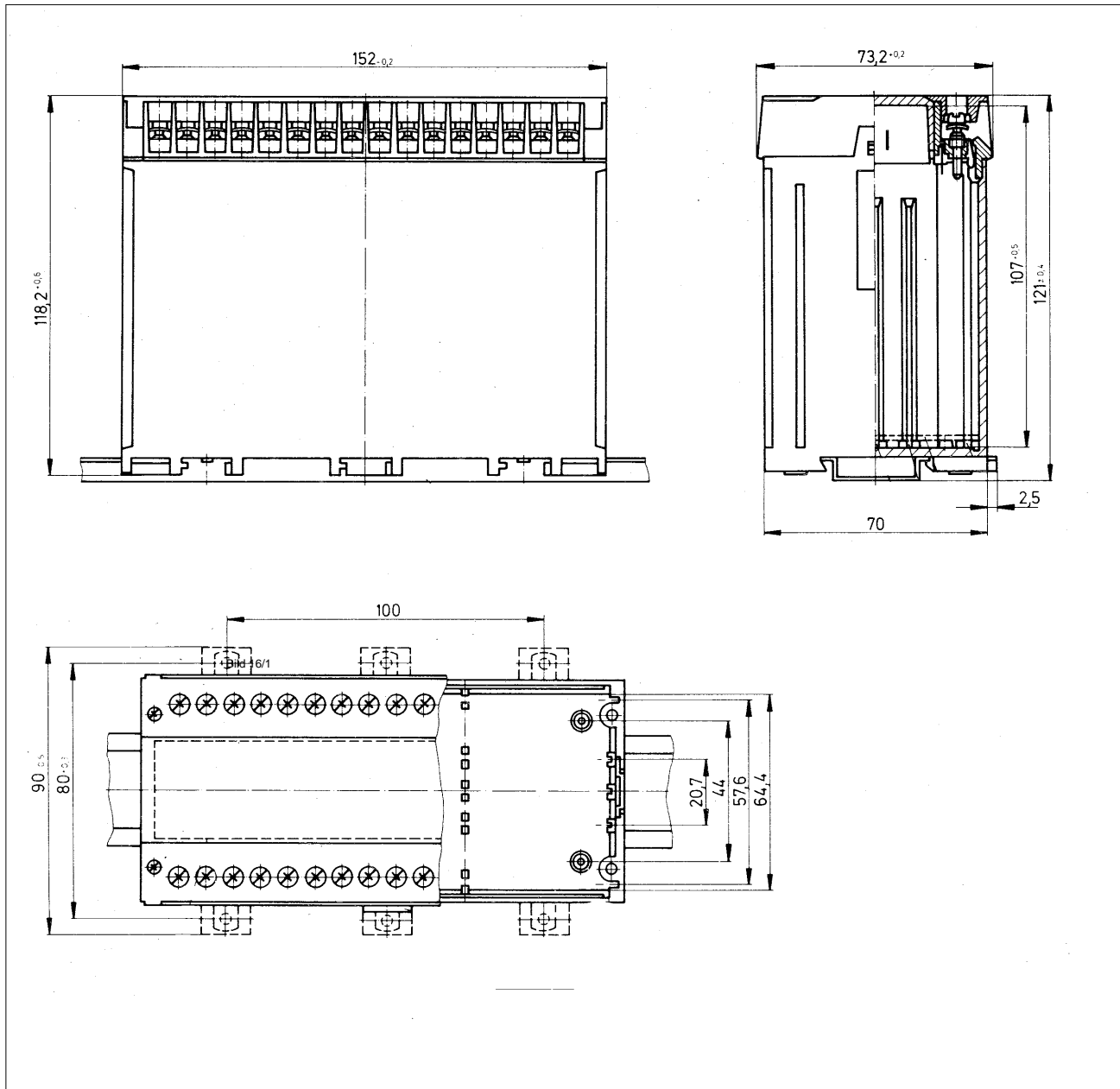

5. Technical Datas

The BPSG controller fulfils the power-failure bridging standard of 20 ms specified by EN 60204 and is therefore suitable for supplying the ...LCT and ...LVT light curtain with voltage.

Characteristic data

Safety category	4 according to EN 954-1 and IEC 61496 or EN 61496 (only in conjunction with the BLCT/ILCT BLVT/ILVT light curtain)
Functions	<ul style="list-style-type: none"> - Programming of 11 BLVT blanking modes - With / without restart interlock (only in conjunction with the BLCT/ILCT BLVT/ILVT light curtain) - With / without contactor / valve control (only in conjunction with the BLCT/ILCT BLVT/ILVT light curtain) <ul style="list-style-type: none"> - Selector switch operation Store and recall up to 5 blanking modes in the BLCT/ILCT BLVT/ILVT light curtain OR store and recall up to 5 operating modes in the PLSG controller OR store and recall up to 5 operating modes in the PLSG controller AND up to 5 blanking modes in the BLCT/ILCT BLVT/ILVT light curtain
Response time	BPSG: 6 ms

Mechanical data

Housing design	Black insulating material, beige cover
Fastening	Snap-on fastening on a hat rail (DIN EN 50022-35), screw fastening
Weight	BLPG: 800 g; BPSG: 1200 g

Operational data

Protection type	IP 20
Protection class	Protective insulation
Ambient operating temperature	-10 to 55 °C
Storage temperature	-25 to 70 °C

Electrical data

Supply voltage	BLPG: 24 V DC + 20% - 10% BPSG: 230 V AC/50Hz +10% -15%, 115 V AC/50Hz +10% -15% or 24 V DC, + 20% - 10%
Outputs (BPSG)	The output contacts are potential-free, force-guided and normally open with a maximum loading capacity of 2 A/250 V AC or 60 V DC, 30 W.
Inputs	Contactor control (SK, EDM-BLVT and EDM-MS) and restart interlock (ST = start button): 0 V to 24 V DC ± 20% (no extraneous voltage!)
Electrical connection	Plug-in terminal strip
Connection cable	Max. 1,5 mm ²



Refer to the light curtain operating manual for important notes and constraints.



All safety instructions are marked with this symbol and must be observed in particular!



Safe functionality of the entire installation is guaranteed only if this operating manual and applicable accident-prevention regulations are observed. Forming part of the controller's scope of delivery, this operating manual must be kept at the controller's site of use.

All instructions in this operating manual must be strictly observed. The manual provides the user with important information concerning proper use of the safety controllers.

Observe applicable standards and guidelines when using the safety controllers. Local authorities or trade associations will provide you with the relevant information. All other applicable regulations and standards issued by the employer's liability insurance associations must be observed too.

Qualified personnel Installation, commissioning and maintenance must only be carried out by qualified personnel.

Danger signs Before commissioning and operating a machine with a safety controller, ensure that nobody is located in the danger zone. A danger sign to this effect must be affixed to the machine.

Light barriers do not provide any protection against flying objects produced through operation of the machine.

During a use of safety light curtains with an external controller or other secondary control units,

operative or organizational measures should ensure deactivation / testing at least once every 24 hours in order to detect and subsequently eliminate any faults on the controllers.

Ensure daily inspection (after 24 hours at the latest):

Using the test rod*, interrupt the light barrier on the transmitting side from the start to the end of the protective field so that the light field is only covered by this part. The green LED (or the yellow LED in the operating mode with restart interlock) must not light up from start to finish.

* The test rod's diameter must correspond to the detection capacity indicated on the receiver's type plate.

Prerequisites for the use of safety light curtains:

- The **safety distance** between the protective field and hazardous area must be large enough to ensure that, during entry into the protective field, the hazardous points cannot be reached before the hazardous movement is interrupted or ended.
- **Access to the hazardous area** must only be possible through the protective field (reaching under, over or around the field must not be possible).
- **Passing through the light curtain** must only be possible if the **restart interlock** is activated on interruption of the light curtain. A new command to activate the next hazardous machine movement must only be implemented via an enabling switch. This start button must not be operable from the hazardous area and must be located at a point from which the accessible area can be viewed without obstruction.
- It must be possible for the hazardous condition of a machine to be terminated by the sensor function.
- Unintentional repetition of a hazardous movement must be prevented by appropriate safety facilities.
- The **safety category** (type 4) of the accident-prevention light curtain should be at least the same as the safety category of the machine control unit.
- **Acceptance test:**
The acceptance test for the installation should be carried out by competent personnel who are in possession of all information provided by the supplier of the machine and the BWS.
- **Annual inspections:**
The operator must ensure that a competent person is assigned the task of inspecting the light curtain and its machine interface on a yearly basis. This person may, for example, be employed by the light curtain's manufacturer or the operator.

On request by the customer, Fiessler Elektronik carries out the acceptance test and annual inspections. In addition, seminars providing customers with training in annual inspections are held at regular intervals.

Service

If you have any questions that cannot be answered by reading this operating manual, please contact us directly.

When calling, please have the following details ready:

- Device designation
- Serial number
- Fault symptoms and description

Fiessler Elektronik GmbH & Co. KG
Kastellstraße 9
D-73734 Esslingen

Phone +49-711-919697-0
Fax +49-711-919697-50
E-mail info@fiessler.de

Maintenance

The devices of the series of BLPG / BPSG... are maintenance-free.

On request by the customer, Fiessler Elektronik GmbH & Co. KG carries out the acceptance test and annual inspections. In addition, seminars providing customers with training in annual inspections are held at regular intervals.

Warranty

The company Fiessler Elektronik GmbH & Co. KG refuses to accept any warranty claims if the device has been opened or if it has been modified.

Returning a unit

If a unit proves defective and needs to be returned, the following details will greatly help us in repairing the fault quickly:

- Exact fault description
 - Has the machine furnished with the light curtain exhibited other faults?
 - Have you noticed any other failures in the past?
 - In which operating mode was the unit last used?

The more precise the fault description, the more efficiently and reliably we will be able to pinpoint and eliminate the fault.

Download area

The latest operating manuals, device descriptions etc. can be downloaded free-of-charge from our homepage.

<http://www.fiessler.de>

Matching light curtains, light grids and switching units

Light curtains, light grids

Suitable safety light barriers with blanking functions can comprise, for instance, devices of the BLCT / ILCT and BLVT / ILCT series. These devices are available as light grids with various beam intervals.

- storage one of **11 blanking modes** in the light grid BLCT, ILCT, BLVT or ILVT
- **storage up to 5 blanking modes** in the light grid BLCT, ILCT, BLVT or ILVT **and recall via a selector switch again**



Switching units

In connection with the switching units of the series PLSG3 and PLSG3K can be stored:

- **storage up to 5 operation modes** in the switching units and recalled with a selector switch again. e.g. cycle control, Muting mode or safety mode (in each case with and without restart interlock, with and without contactor control)
- **storage up to 5 modes of operation** in the switching units and at the same time can be stored **up to 5 blanking modes** in the light grids BLCT, ILCT, BLVT or ILVT **and recall via a selector switch again**



Additional safety products



Footmats

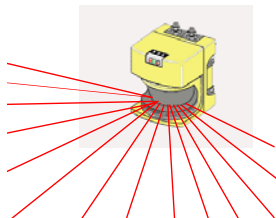

Laser scanners



Parametrizable safety controller FPSC

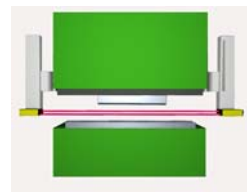

Press brake protection system AKAS



Light curtains for safety, control and measurement

Service

Safety seminars and integration support by our service team.

Certification

A quality management system was introduced at an early stage to guarantee the high quality of Fiessler safety equipment. Fiessler Elektronik is certified according to DIN ISO EN 9001. The company's own electromagnetic compatibility laboratory tests products on a regular basis. All safety equipment complies with national and European standards. Development takes place in consultation with the relevant trade associations. Certification is received followed rigorous tests by the Technical Inspection Board.



Recognition

by Baden Württemberg's ministry of economy of outstanding performance by the innovative AKAS safety system.



Fiessler Elektronik GmbH & Co. KG
Kastellstr. 9
D-73734 Esslingen

Phone: +49(0)711 -91 96 97-0
 Fax: +49(0)711-91 96 97-50
 Email: info@fiessler.de
 Internet: www.fiessler.de

Represented in all major countries

