

Muting controller **PLSG1**
Muting controller **PLSG2**
Universal controller **PLSG3**

Operating manual

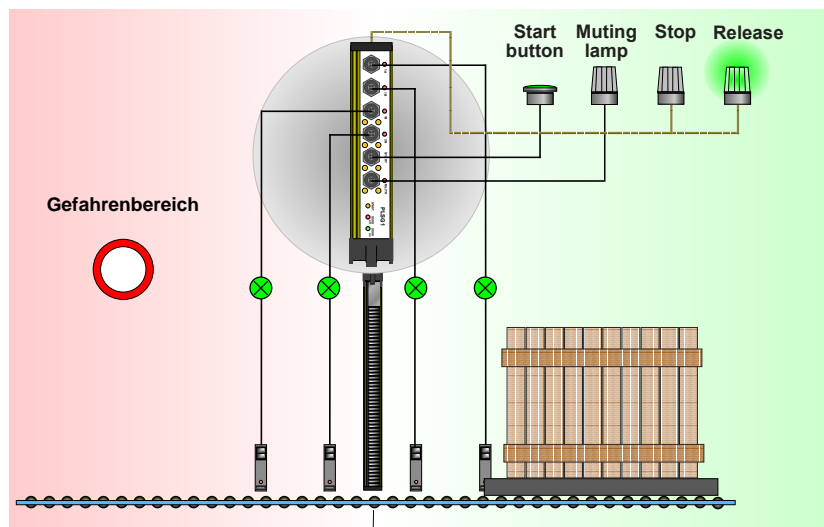

CONTENTS:

Safety instructions

Application notes

Installation

Electrical connection

Commissioning

Technical specifications

Accessories



BG
Approved



| Chapter | Contents | Page | | |
|---------|--|-------|-------|-------|
| | | PLSG1 | PLSG2 | PLSG3 |
| 1. | Safety instructions | 4 | 4 | 4 |
| | Prerequisites for a use of safety light curtains | 4 | 4 | 4 |
| 2. | Device overview / Features / Areas of application | 5 | 5 | 5 |
| 3. | Description of functions | 6 | 6 | 6 |
| 3.1 | Muting functions | 6 | 6 | 6 |
| 3.1.1 | Muting | 6 | 6 | 6 |
| 3.1.2 | Muting sensors, prevention of muting manipulation | 6 | 6 | 6 |
| 3.1.3 | Muting time limitation, deactivation of muting time limitation | 6 | 6 | 6 |
| 3.1.4 | Renewed muting | 6 | 6 | 6 |
| 3.1.5 | Muting lamps | 7 | 7 | 7 |
| 3.1.6 | Override after unscheduled stop (for example, belt standstill) | 7 | 7 | 7 |
| 3.1.7 | Muting with 4 muting sensors (example) | 7 | 7 | 7 |
| 3.1.8 | Muting with 2 muting sensors (example) | 7 | 7 | 7 |
| 3.1.9 | Delayed end of muting | - | 7 | 7 |
| 3.1.10 | Immediate end of muting when the protective field is cleared again | - | 8 | 8 |
| 3.1.11 | Delayed end of muting and immediate end of muting when the protective field is cleared again..... | - | 8 | 8 |
| 3.2 | Control and switching function | 9 | 9 | 9 |
| 3.2.1 | 2-stage deactivation of outputs (for example, robot safeguarding, delayed switching of OSSD 2).... | - | 9 | 9 |
| 3.2.2 | Emergency-stop circuit monitoring (guarding door & grids, emergency-stop switches) | - | - | 9 |
| 3.2.3 | With restart interlock (start via button) | 9 | 9 | 9 |
| 3.2.4 | Without restart interlock | - | 9 | 9 |
| 3.2.5 | Two-hand start (start via two-hand button) | - | - | 9 |
| 3.2.6 | Contactor and valve control | 9 | 9 | 9 |
| 3.3 | Control functions | - | - | 10 |
| 3.3.1 | Restart interlock only during hazardous movement | - | - | 10 |
| 3.3.2 | Cycle control (automatic start of work cycles during insertion operations) | - | - | 10 |
| 3.4 | Teach-in of beam blanking functions for the BLVT light grid | - | - | 11 |
| 3.4.1 | One-time or infrequently modified blanking | - | - | 11 |
| 3.4.2 | Regular or frequently modified blanking (optionally with BLPG) | - | 12 | 12 |
| 3.5 | Switchover between operating modes / beam blanking | | | |
| | Via an external selector switch selector switch (optional with BLPG)..... | - | - | 13 |
| 3.5.1 | Switchover between up to 5 operating modes | - | - | 13 |
| 3.5.2 | Switchover between up to 5 operating modes and up to 5 beam blanking modes | - | - | 14 |
| | Example | - | - | 15 |
| 4. | Setting muting times | - | 16 | 16 |
| 4.1 | <u>Setting muting time limits</u> | - | 16 | 16 |
| 4.2 | <u>Setting delayed of muting</u> | - | 17 | 17 |
| 5. | Setting the display language German / English | 18 | 18 | 18 |

Electrical connection PLSG 1 see on page 27

| Chapter | Contents | Page | | |
|------------|--|-------|-------|-------|
| | | PLSG1 | PLSG2 | PLSG3 |
| 6. | Setting the operating mode only PLSG2 / PLSG3 (Hex switches) | - | 19 | 19 |
| 6.1 | Procedure of setting operating modes / Example | - | 20 | 20 |
| 6.2 | Aid in determining the correct operating-mode table | - | 21 | 21 |
| | Operating mode tables for PLSG2 / PLSG3 | - | 22 | 22 |
| 6.3 | 1. Muting mode with restart interlock, without / with contactor control | - | 22 | 22 |
| | PLSG3: Selection of emergency-stop circuit & two-hand start | | | |
| 6.4 | 2. Muting mode without restart interlock, without / with contactor control ... | - | 23 | 23 |
| | PLSG3: Selection of emergency-stop circuit | | | |
| 6.5 | 3. Muting mode with restart interlock only during hazardous movement, | - | - | 24 |
| | with contactor control PLSG3: Selection of emergency-stop circuit | | | |
| 6.6 | 4. without muting functions with restart interlock (two-hand start) | - | - | 24 |
| | with/without contactor contr. with emergency-stop circuit monitoring | | | |
| 6.7 | 5. without muting functions with restart interlock, without / with contactor control | - | - | 25 |
| 6.8 | 6. Cycle control without / with contactor control, without / with muting | - | - | 26 |
| | (for insertion operations) PLSG3: Selection of emergency-stop circuit | | | |
| 7. | Electrical connection | 27 | 27 | 27 |
| 7.1 | Selection of required connection diagrams | 27 | 27 | 27 |
| 7.2 | Terminal designations | 28 | 28 | 28 |
| 7.2.1 | 1. Contactor and valve control (EDM) (external elements) | 29 | 29 | 29 |
| 7.2.2 | 2. Restart interlock (start button) or override after unscheduled stop | 29 | 29 | 29 |
| 7.2.3 | 3. Two-hand start in case of muting mode with restart interlock | - | - | 30 |
| 7.2.4 | 4. Emergency-stop circuit with muting modes | - | - | 30 |
| 7.2.5 | 5. 2-stage deactivation of outputs (for example, robot safeguarding, delayed OSSD 2 switching)... | - | 31 | 31 |
| 7.2.6 | 6. Muting with 4 sensors | 32 | 32 | 32 |
| 7.2.7 | 7. Muting with 2 sensors | 33 | 33 | 33 |
| 7.2.8 | 8. Stoppage of muting time limitation (for example, on belt standstill) | 34 | 34 | 34 |
| 7.2.9 | 9. External displays for: Restart interlock, protective field state | - | - | 35 |
| 7.2.10 | 10. Cycle control (automatic start of work cycles during insertion operations)..... | - | - | 36 |
| 7.2.11 | 11. Two-hand start and emergency-stop circuit monitoring without muting functions | - | - | 37 |
| 7.2.12 | 12. Optional: Beam blanking functions for the BLVT light grid (with an external key switch). | - | 38 | 38 |
| 7.2.13 | 13. Optional: Switchover between operating modes via an external selector switch | - | - | 39 |
| 8. | Dimensional drawings / assembly | 40 | 40 | 40 |
| 8.1 | Dimensional drawings | 40 | 40 | 40 |
| 8.2 | Assembly / dismantling | 41 | 41 | 41 |
| 9. | Technical data | 42 | 42 | 42 |
| 10. | Fault diagnosis / Trouble-shooting / Remedy | 43 | 43 | 43 |
| 11. | Service / Maintenance / Warranty | 47 | 47 | 47 |
| 12. | Documentation of operating mode settings | 48 | 48 | 48 |
| 13. | Order codes | 49 | 49 | 49 |

 All safety instructions are marked with this symbol and must be observed in particular!

Safe functionality of the entire installation is guaranteed only if this operating manual and applicable accident-prevention regulations are observed. Forming part of the controller's scope of delivery, this operating manual must be kept at the controller's site of use.

All instructions in this operating manual must be strictly observed. The manual provides the user with important information concerning proper use of the PLSG safety controller. Before commissioning the ...LVT safety light curtains with the PLSG safety controller, make sure to read both operating manuals.

Observe applicable standards and guidelines when using safety light curtains. Local authorities or trade associations will provide you with the relevant information. All other applicable regulations and standards issued by employers' liability insurance associations must be observed too.

Qualified personnel Installation, commissioning and maintenance must only be carried out by qualified personnel.

Danger signs When operating a machine with ...LVT safety light curtains, ensure that nobody is located in the danger zone. A danger sign to this effect must be affixed to the machine.

Light barriers do not provide any protection against flying objects produced through operation of the machine.

During a use of safety light curtains with an external controller or other secondary control units, operative or organizational measures should ensure deactivation / testing at least once every 24 hours in order to detect and subsequently eliminate any faults on the controllers.

Ensure daily inspection (after 24 hours at the latest): Using the test rod*, interrupt the light barrier on the transmitting side from the start to the end of the protective field so that the light field is only covered by this part. The green LED (or the yellow LED in the operating mode with restart interlock) must not light up from start to finish.* The test rod's diameter must correspond to the detection capacity indicated on the receiver's type plate.

When using BLVT - blanking functions, make sure to observe the **additional safety instructions** and all other specifications in the BLVT operating manual.

When using cascaded light grids, make sure to observe the **additional safety instructions** and all other specifications in the ...LVTK operating manual.

Prerequisites for the use of safety light curtains:

- The **safety distance** between the protective field and hazardous area must be large enough to ensure that, during entry into the protective field, the hazardous points cannot be reached before the hazardous movement is interrupted or ended.
- **Access to the hazardous area** must only be possible through the protective field (reaching under, over or around the field must not be possible).
- **Passing through the light curtain** must only be possible if the **restart interlock** is activated on interruption of the light curtain.
- A new command to activate the next hazardous machine movement must only be implemented via an enabling switch. This start button must not be operable from the hazardous area and must be located at a point from which the accessible area can be viewed without obstruction.
- It must be possible for the hazardous condition of a machine to be terminated by the sensor function.
- Unintentional repetition of a hazardous movement must be prevented by appropriate safety facilities.
- The **safety category** (type 4) of the accident-prevention light curtain should be at least the same as the safety category of the machine control unit.
- **Acceptance test:**
The acceptance test for the installation should be carried out by competent personnel who are in possession of all information provided by the supplier of the machine and the BWS.
- **Annual inspections:**
The operator must ensure that a competent person is assigned the task of inspecting the light curtain and its machine interface on a yearly basis. This person may, for example, be employed by the light curtain's manufacturer or the operator.

On request by the customer, Fiessler Elektronik carries out the acceptance test and annual inspections. In addition, seminars providing customers with training in annual inspections are held at regular intervals.



PLSG3

ULVT/ BLVT light grid

Connectable components:

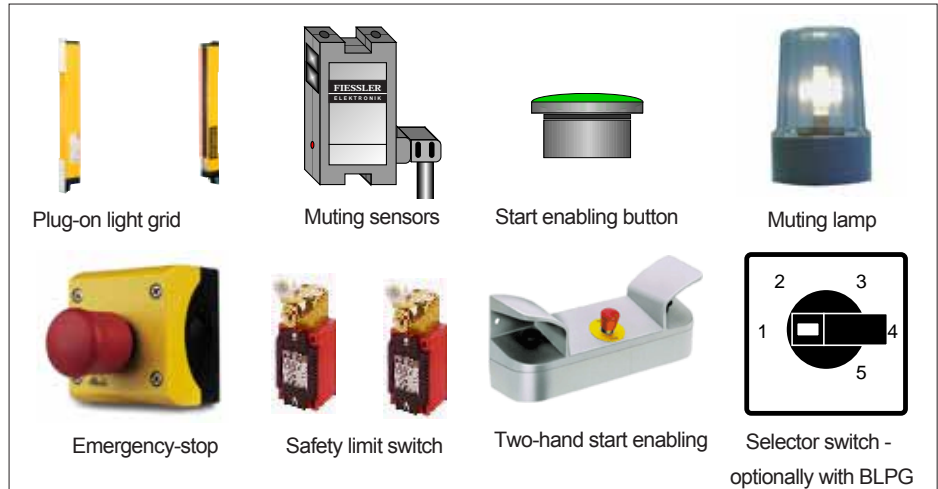

| Functions | PLSG1 | PLSG2 | PLSG3 | Setting the operating mode See Chapter 6 on page 20 | starts from page |
|---|-------------------|------------------------------|----------------------|--|------------------|
| | Muting controller | Muting controller | Universal controller | | |
| Muting with muting time monitoring | ● | ○ | ○ | Brief bypass of the light grid is possible! If material comes to a stop in the muting zone, muting is deactivated or the light grid is activated after the muting time has elapsed. | 6 |
| Delayed end of muting | - | ○ | ○ | Manipulation-proof muting when material flows exclusively outward from the hazard zone. Muting sensors are located in the hazard zone. | 8 |
| Immediate end of muting on clearing of the protective field | - | ○ | ○ | The muted state persists only as long as absolutely necessary. If this function is active, there is no muting time limit. | 8 |
| Override (for example, on belt standstill) after unscheduled stop | ● | ○ | ○ | | 7 |
| Contactors / valve control of subsequent switching elements | ● | ○ | ○ | | 9 |
| Restart interlock Start enabled via a button | ● | ○ | ○ | | 9 |
| Restart interlock only during hazardous movement (for example, during insertion operations) | - | - | ○ | Infiltration of the protective field is possible during a standstill or non-hazardous movement without renewed enabling of start. 2 outputs for external display: Protective field state and restart interlock | 10 |
| Cyclic control (for example, during insertion operations) with work time monitoring (30s or 120s) | - | - | ○ | Cyclic infiltration of the protective field controls machine operation 1-cycle, 2-cycle, 3-cycle or 4-cycle operation 2 outputs for external display: Protective field state and restart interlock | 10 |
| Emergency-stop circuit monitoring Guard doors, emergency-stop switches | - | - | ○ | | 9 |
| Two-hand start Start enabled via two-hand switch | - | - | ○ | | 9 |
| 2-stage output deactivation Deactivation of control drives (for example, robots) | - | ○ | ○ | On interruption of the protective field, OSSD1 switches off immediately and instructs the machine (for example, robot) to shut down within 0.5 s. After 0.5 s, OSSD2 safely deactivates the machine. | 9 |
| Display Status and error messages | - | ● | ● | 2 x 8 character LCD | 18 |
| BLVT light grid blanking functions 11 protective-field blanking modes | - | - | ○ | In case of one-time or infrequently modified blanking Protective field blanking in the light grid is performed through one-time programming with the hex switches after a voltage reset. The blanking function remains saved in the light grid until new programming. | 11 |
| With additional BLPG programming unit a) 11 BLVT protective field-blanking modes b) Selector switch operation Storage and recall of operating modes / protective field-blanking modes | - | only with BLPG only blanking | only with BLPG | a) In case of regular or frequently modified blanking. Protective field blanking in the light grid is performed through actuation of a key switch b) Selector switch operation Switchover between up to 5 PLSG-operating modes and / or up to 5 protective field-blanking modes for the BLVT light grid using a selector switch | 12 |

○ Function can be de-selected

● Function cannot be de-selected

- Function is not available

3.1.1 Muting (bypass)

Muting means brief bypass of a safety light barrier if this is required by the working cycle. For this purpose, +24V must be applied to muting input pairs 1A - 2A or 2A - 1B or 1B - 2B. Muting is only permissible if the hazard zone remains inaccessible or no hazardous movement is involved during the work cycle. This is ensured if material passes through the protective field of the safety light grid so as to prevent access to the hazardous zone between the material and the safety light grid or preclude hazardous movement. Applications include palleting machines, narrow-aisle storage facilities, forklift entrance routes, production cells, bending presses, presses with material input etc.

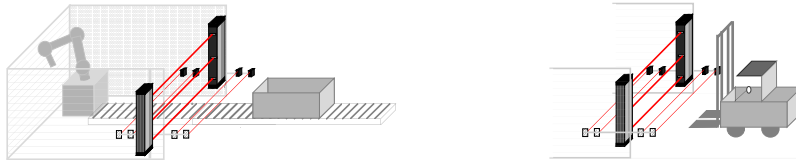

3.1.2 Muting sensors

Differentiation between conveyed material) and humans or detection of non-hazardous movement is realized by at least 2 mutually independent muting sensors. These can comprise light barriers (for example, GR or MFL series from Finessler-Elektronik), inductive sensors, cam switches or limit switches. The muting sensors must be conductive in the muted state.

Prevention of muting manipulation through proper assembly The muting sensors must be installed so that the triggering sensor pairs 1A-2A, 2A-1B, 1B-2B cannot be interrupted simultaneously by humans.

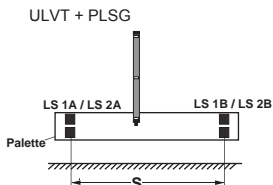

For proper bypass, S must be smaller than or equal to the length of the pallet.

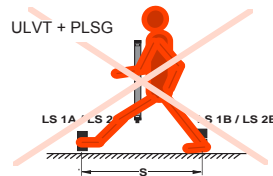

The distance S must be large enough to prevent simultaneous interruption of muting sensors LS 1A / LS 2A and LS 1B / LS 2B by humans.

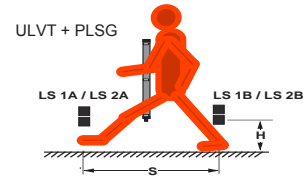

If necessary, the clearance H to the passable area or the distance S should be increased.

3.1.3 Muting time limit – monitoring of max. muting time

To prevent a safety light curtain from being continuously interrupted by intentional manipulation, a dependable time monitor has been installed additionally. The maximum muting time on the PLSG1 has been set firmly to 1 h. On the PLSG2 and -3, the muting function is disabled after an adjustable time of 1 s to 253 s or 1 h. The default maximum muting time on the PLSG2 and PLSG3 is 30 s. **The muting time should be as short as permitted by the involved process** (see Page 16). Furthermore, the muting time limiter is able to check whether a muting sensor is mistakenly in the muted state. If the muting function is interrupted due to time overflow, any new muting of the safety light barrier is only possible if all muting sensors have returned into the non-muted condition. **Important: If the function "Immediate end of muting on clearing of the protective field" has been selected, there is no muting time limit.**

| PLSG1 | PLSG2/3 |
|-------|---------------|
| Fixed | Adjustable |
| 1 h | (see Page 16) |
| | 1 s to 253 s |
| | or 1 h |

Stoppage of muting time limitation:

This prevents unwanted stop in the case of material accumulation (see Page 35). The muting time limit can be stopped, for example, in case of material accumulation via a machine contact which applies + 24 V to the TR input to prevent unwanted deactivation of the PLSG outputs. Time monitoring is resumed as soon as status of a muting sensor changes.

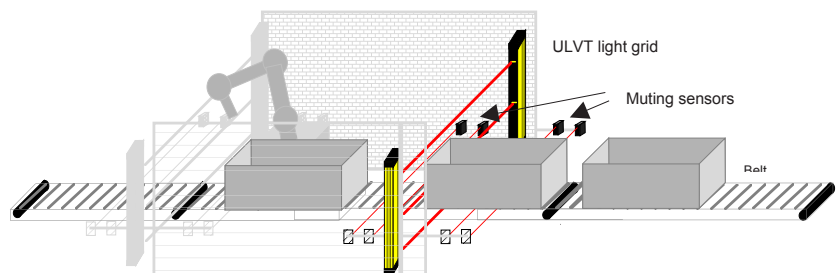

3.1.4 Renewed muting state only after release of all muting sensors

Renewed muting of the safety light barrier is possible only if all muting sensors are in a non-muted state at the same time. If the light curtain is interrupted after end of muting, e.g. due to expiry of the muting time limit, the outputs are deactivated. If the protective field is clear again, the outputs are activated again either automatically or via the start button, in accordance with the selected operating mode.

3.1.5 Muting lamp

Muting (bypass) of the light grid is permitted only if this is indicated by a lamp. For this purpose, the PLSG contains an internal long-life muting lamp (yellow LEDs). It lights up whenever the light barrier is muted. In addition, an external muting lamp (24 V max. 0.5 A, min. 50 mA) can be connected. If either the internal or the external muting lamp is faulty or not connected, the other operational muting lamp indicates the muting state by flashing instead of shining continuously. This draws attention to the incident. If no lamp functionality is available, the light barrier will not be muted. Consequently, connection of an external muting lamp makes the muting function much more dependable.

3.1.6 Override after an unscheduled stop

This enables start after an unscheduled stop in the muted state. If the muting time elapses or the power supply is reset, the output channels of the PLSC are deactivated when the protective field is interrupted, even if a muting sensor pair of relevance to muting is in the muted state. In this case, the outputs of the PLSG can be reactivated again by pressing the start button, as access to the hazardous area is blocked by the material in the protective area and the detection range of the muting sensors. However, the outputs of the PLSG will open again if the protective field is not cleared within a period of 35 s after pressing the start button. Renewed muting of the safety light barrier is possible only if all muting sensors are in a non-muted state at the same time. The override function is not available in the "cycle control" operating mode. The start / override button must be installed so that it can only be activated from outside the hazardous area while leaving a clear view of this area.

3.1.7 Muting with 4 muting sensors (examples)

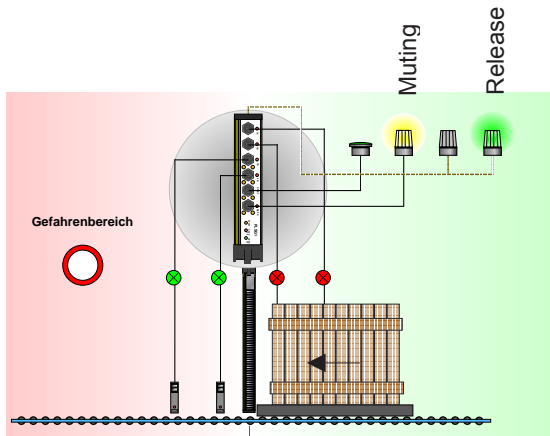

Muting remains enabled until at least 2 neighbouring muting sensors are interrupted.

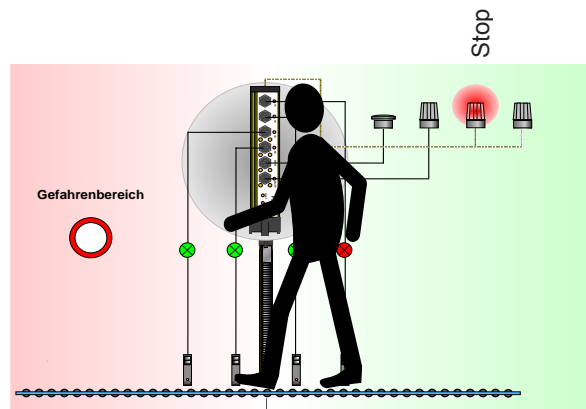

If the muting sensors are arranged properly, it is not possible to simultaneously interrupt any of the sensor pairs.

3.1.8 Muting with 2 muting sensors (for example, cross-muting)

Important!

The point of intersection of the two muting sensors' beams (GR 5/24) must lie inside the hazard zone behind the safety light grid.

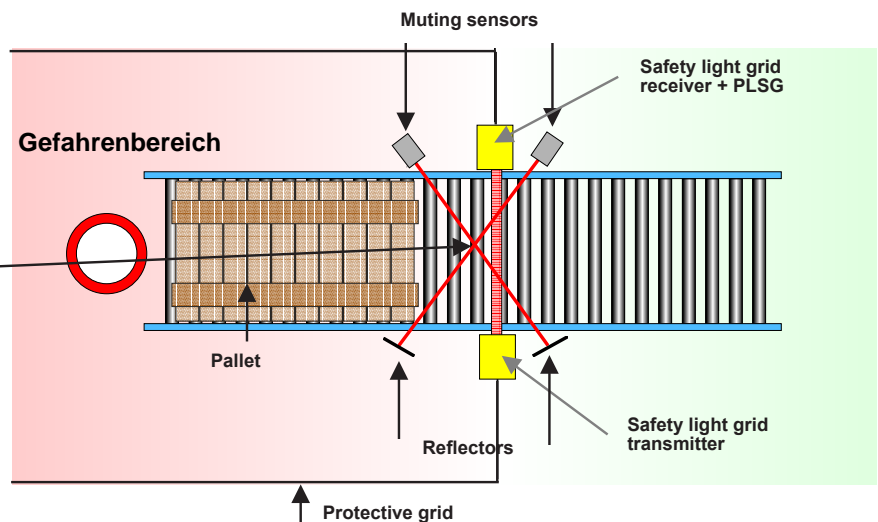

3.1.9 Delayed end of muting (settings are provided on Page 17)

Manipulation-proof muting when material flows exclusively outwards from the hazard zone. This muting mode is only permissible when material is conveyed out of the hazard zone.

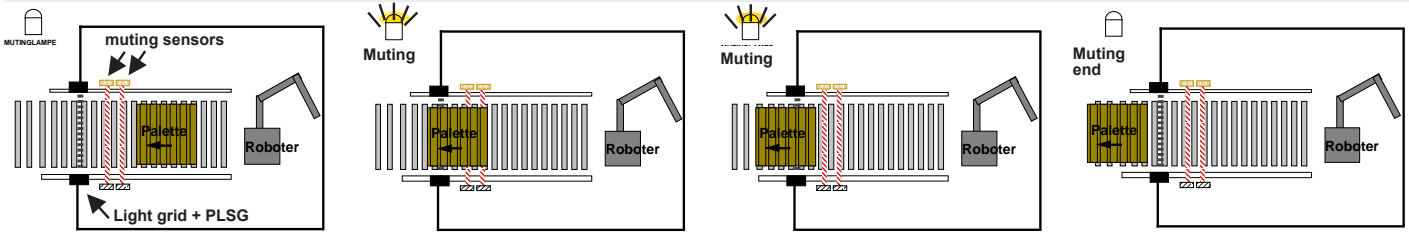

As soon as the pallet interrupts the beams of both muting sensors located behind the safety light grid facing the hazard zone, the safety light grid is bypassed. Once the pallet has moved on to a point where muting sensors is free again, the muting state persists for a short, adjustable delay period, enabling the material to leave the range of the safety light grid without deactivation of the PLSG outputs. The setting of this termination delay period depends on the conveying speed and on the distance between the safety light grid's protective field and muting sensor. The muting termination delay period on delivery is preset to 0 s (max. 30 s, or 195 s in conjunction with 3.1.10).

The muting termination delay period must be set as short as possible to guarantee soonest possible stop of muting after the material has left the protective field.

This muting function is especially immune to manipulation, because the protective field must be infiltrated before the muting sensors can be interrupted.

If the muting sensors are installed in front of the protective field outside the hazardous area, muting with a termination delay period is not permitted.

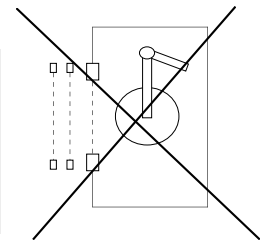

3.1.10 Immediate end of muting when the protective field is clear again

No muting time limit

The muting state remains set only as long as it is absolutely required. The function "muting termination if protective field is cleared again" stops muting of the safety light grid as soon as the protective field is cleared after passage of the material. A new muting state is possible only after restoration of all muting sensors to the non-muted state. This makes it possible to detect a person travelling on a floor conveyor if there is a gap between the conveyed material and the person.

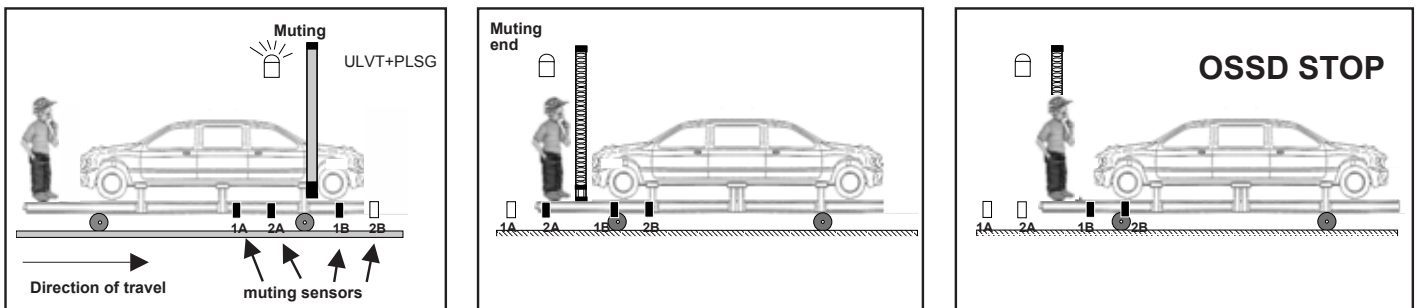

This muting function cannot be used if the distance between the conveyed material items is sometimes smaller than the distance between the muting sensors that are remotest from each other.

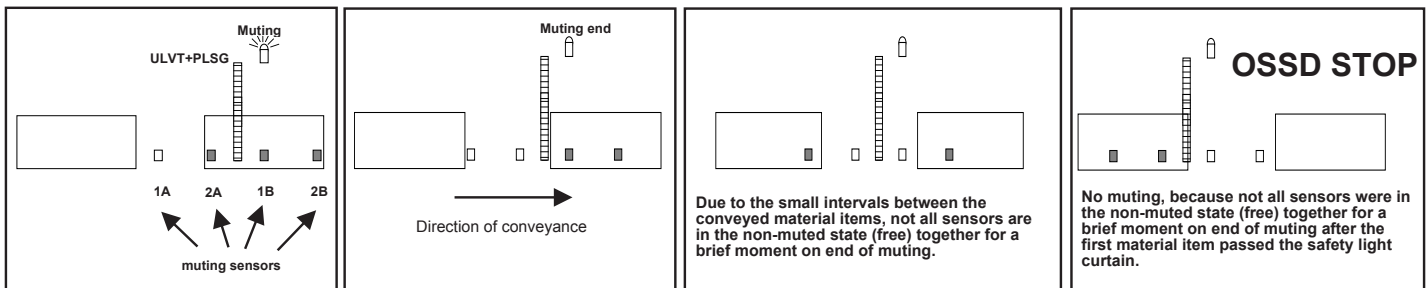

3.1.11 Combination: Delayed end of muting / immediate end of muting when the protective field is clear again

Manipulation-proof muting if the material flow is only directed outwards from the hazard zone at extremely variable conveyor belt speeds. This combined operating mode is intended for use at extremely variable material conveying speeds, if the material is only transported outwards from the hazard zone. The muted state is terminated as soon as the material has passed the protective field. This permits the muting termination delay to be set so as to maintain dependable muting even at very slow conveyor speeds and prevent unprotected entry into the hazard zone immediately after passage of the material at high conveyance speeds. However, this muting function cannot be used if the distance between the conveyed items is sometimes smaller than the distance between the protective field and the muting sensor located furthest away inside the hazard zone.

3.2.1 Two-stage deactivation of outputs (for control drives, e.g. robot safeguarding)

PLSG2 / PLSG3

Output OSSD 1 opens immediately, i.e. with the maximum reaction time of 3.5 ms. OSSD 2 opens with a delay of 0.5 s.

Observe the safety notes in circuit diagram 5.

Possible application: If the hazardous movement is to be stopped in a controlled manner and the control device unit is not fail-safe. For this purpose, the control is driven via OSSD 1. If the control does not stop a hazardous movement when OSSD 1 is inactive, OSSD 2 disconnects the power supply and any open brake after 0.5 s, so that the hazardous movement comes to an uncontrolled stop. In this case, the longer response time of 0.5 s must be considered when calculating safety clearances to the hazardous area.

3.2.2 Emergency-stop circuit monitoring (monitoring of guard doors and emergency-stop buttons)

PLSG3

One channel of a two-channel emergency-stop circuit with NC contacts can be connected each to muting sensor terminals 1A and 2A. Pulsation of these circuits permits monitoring of cross-connections between the channels. If one channel is opened and closed again, the PLSG outputs are activated only if the other channel was interrupted simultaneously with the first channel. If OSSD2 cut-off delay was also selected, output OSSD2 is deactivated with a delay even on actuation of the emergency-stop function.

Not suitable for applications in which the emergency-stop function must be used to disconnect the machine's power supply.

3.2.3 Restart interlock (start of hazardous movement, enabled only via command initiation)

PLSG1 / PLSG2 / PLSG3

The restart interlock prevents automatic release of the switching outputs after an interruption and reactivation of the protective field (for example, on passage through the field). When the protective field is clear again, the PLSG outputs are only reactivated after the start button or two-hand button has been pressed and released.

The start button must be installed so that it can only be activated from outside the hazardous area while leaving a clear view of this area.

3.2.4 Without restart interlock

PLSG2 / PLSG3

Start of hazardous movement, enabled without command initiation.

After an interruption and re-activation of the protective field the PLSG switching outputs are released immediately.

In this operating mode, it must not be possible to step behind the safety light grid (refer to Chapter 4.3 of the ULVT operating manual).

3.2.5 Two-hand start

PLSG3

Prevents inadvertent start of hazardous movement, e.g. in passable press areas.

In order to deliberately restart hazardous movement after an interruption of the protective field, there is the possibility of a two-hand-start. For this, it is necessary to connect a NO contact of a button to muting sensor terminals 1A, and a NC contact of another button to muting sensor terminals 2A. One exception is the operating mode: "Two-hand start with emergency circuit monitoring". This operating mode requires the connection to be made at 1B, 2B instead of 1A, 2A. If the protective field is clear, the PLSG outputs can be enabled again if these two buttons are actuated simultaneously with a maximum tolerance of 0.5 s and released. There is no limit on time offset during release.

The start buttons must be installed so that they can only be activated from outside the hazardous area while leaving a clear view of this area.

3.2.6 Contactor and valve control (EDM) (control of subsequent switching elements)

PLSG1 / PLSG2 / PLSG3

Switching elements connected downstream from the PLSG (relays, contactors, valves) are checked for proper switching. Before every release of a switching output, a check is made as to whether the connected switching elements are also released, i.e. whether their force-guided auxiliary NC contacts are closed; only under these circumstances can the outputs be enabled again. If the downstream switching devices are not activated within 750 ms after the outputs are enabled, the outputs are disabled again and can be reactivated at the earliest after 1.3 s. This is to identify any defects on the cut-off elements before they become hazardous (refer to connection diagram 1).

Always monitor the cut-off devices that directly disable hazardous movement, i.e. the last links of the chain.

3.3.1 Restart interlock only during hazardous movement

PLSG3

Actuation of the start button is only necessary if the protective field has been interrupted during hazardous movement.

After an interruption of the protective field and its reactivation, the restart interlock is activated only if the switching elements connected downstream from the PLSG are active. If the downstream switching elements are inactive, i.e. no hazardous movement is in progress, the PLSG outputs are enabled immediately after an interruption and subsequent clearing of the protective field without actuation of the start button. For this function, the downstream switching elements must be monitored by the valve and contactor control (EDM). If there is a voltage of +24V at the EDM, i.e. the switching elements are inactive, the restart interlock is deactivated. If the EDM is driven with +24 V for longer than 1h , the switching outputs of the PLSG are interrupted. If the protective field is clear, the outputs can be enabled again by pushing the start button. In this case, the regular valve and contactor control system is active. In the operating mode with external display, terminal MS1A+ indicates the protective field's status (conductive = protective field clear) while terminal MS2A+ indicates the restart interlock's status (conductive = start button must be actuated). This function cannot be combined with the emergency-stop circuit. Inputs MS1B and MS2B are available for muting.

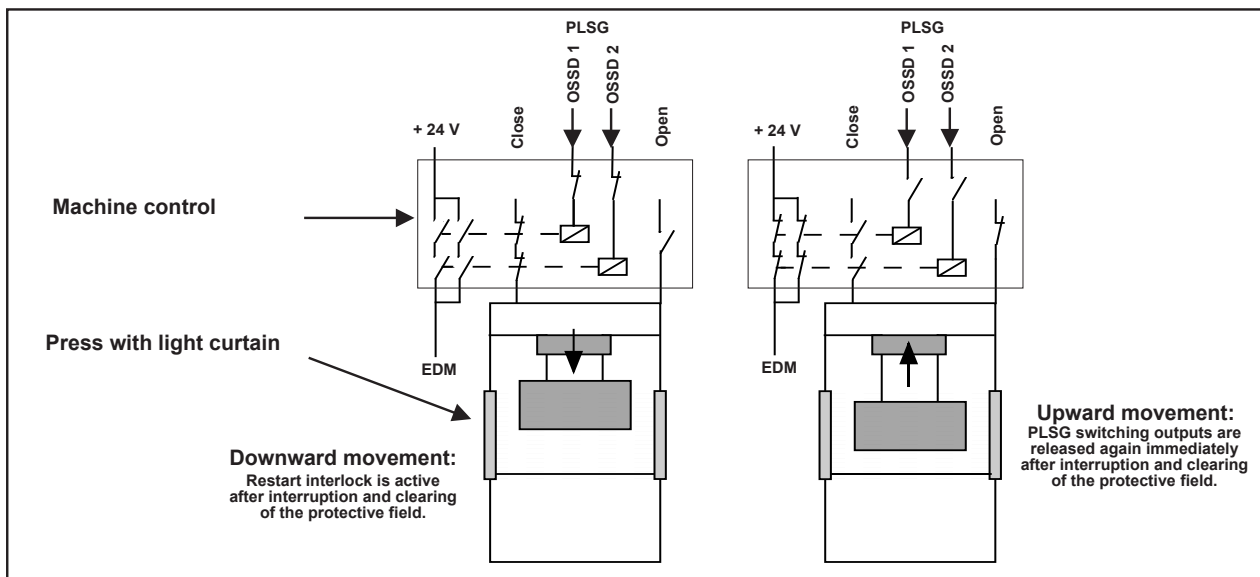

Applications with cyclic infiltration of the protective field during non-hazardous movement or machine standstill can be ergonomically safeguarded in this operating mode without a use of muting sensors.

In this operating mode, it must not be possible to step behind the safety light grid (refer to Chapter 4.3 of the ULVT operating manual).

3.3.2 Cyclic control (machine control defined by the operator's work patterns)

PLSG3

The cycle mode enables an automatic restart of the machine after a predefined number of entries (cycles) into the protective field. The maximum time period during which the cycles must be performed is monitored. You may enter 1 - 4 cycles and a monitoring time of 30s or 120 s. According to the programmed number of cycles, the machine automatically performs one work cycle, and then waits max. 30 or 120 s, according to the preset time, for the programmed number of cycles. If the time period is longer, the restart interlock is activated. If during hazardous movement, the protective field is infiltrated, the PLSG outputs are disabled and the restart interlock is activated. After a voltage reset, the restart interlock is activated too. The PLSG outputs can be closed again by performing the preset number of entries into the protective field and subsequent activation of the start button (within the preset monitoring time). The end of the work cycle is signalled to the machine by a machine contact that is connected at the cycle reset input channel TR. If 0V is at the cycle reset input channel TR, i.e. the machine contact is open, the PLSG outputs are interrupted and the cycle counter as well as the time monitoring are reset. As long as the machine contact is open, entries into the protective field are not counted for the start of the work cycle. If the machine contact closes again, therefore providing + 24 V to the cycle reset input channel TR, time monitoring is started and all subsequent interruptions of the protective field are counted for the start of the work cycle. Wiring diagram 10 shows this with an example of two-hand control.

In the operating mode with external display, terminal MS1A+ indicates the protective field's status (conductive = protective field clear) while terminal MS2A+ indicates the restart interlock's status (conductive = start button must be actuated). This function cannot be combined with the emergency-stop circuit. Inputs MS1B and MS2B are available for muting.

Anwendungen sind Einlegearbeiten mit Arbeitsüberwachung zum Steuern von Pressen mit einer Tischhöhe über 750 mm oder von RundCycletischen. Neither muting time limitation nor override is possible in a combination of cycle control and muting. Applications include insertion operations with work monitoring for control of press brakes with a table height of more than 750 mm or revolving-transfer tables.

In this operating mode, it must not be possible to step behind the safety light grid (refer to Chapter 4.3 of the ULVT operating manual)
This operating mode is permitted only when using hand or finger protection (light curtain's detection capacity <= 30 mm)

3.4.1 One-time or infrequently modified blanking:

Teach-in of beam blanking functions with **PLSG3 via hex switches** (also refer to the BLVT operating manual)

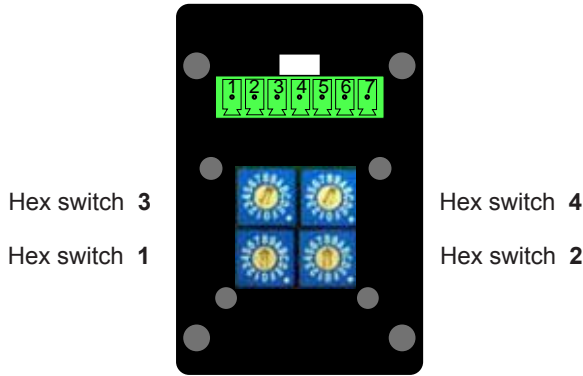

Teach-in procedure:

1. Set the hex switches to the desired blanking mode (refer to the table).
2. Position the barriers to be blanked out in the protective field.
The first beam (as seen from the plug) must not be dark during teach-in.
 Otherwise the light curtain assumes the error state and the orange and yellow LEDs on the receiver start to flash rapidly (about 4 times per second).
3. Reset the power supply (turn the operating voltage off and on again).
4. The PLSG3 displays the blanking mode to be programmed.
5. The red and orange LEDs of the BLVT come on.
6. The green LED of the BLVT comes on; depending on the selected blanking mode, the yellow and orange LEDs flash.

Setting the operating mode of the PLSG3:

1. Turn off the PLSG3.
2. Set the hex switches to the desired PLSG3 operating mode (refer to Chapter 6 on operating-mode tables).
3. Turn on the PLSG3.



| Beam blanking functions of the BLVT light grid | |
|---|--|
| Refer to Chapter 3.5 and the BLVT operating manual. | |
| 12 34 | |
| 55 00 | No blanking |
| 55 11 | Static blanking |
| 55 22 | Static blanking with 1-beam reduced resolution |
| 55 33 | Static blanking with 2-beam reduced resolution |
| 55 44 | Dynamic blanking |
| 55 55 | Dynamic blanking with 1-beam reduced resolution |
| 55 66 | Dynamic blanking with 2-beam reduced resolution |
| 55 77 | 1-beam reduced resolution |
| 55 88 | 2-beam reduced resolution |
| 55 99 | Only ignore 1 beam once |
| 55 AA | Only ignore 2 beams once |

3.4.2 In case of regular or frequently modified blanking:

Teach-in of beam blanking functions with BLPG via an external key switch (BLVT programming unit)

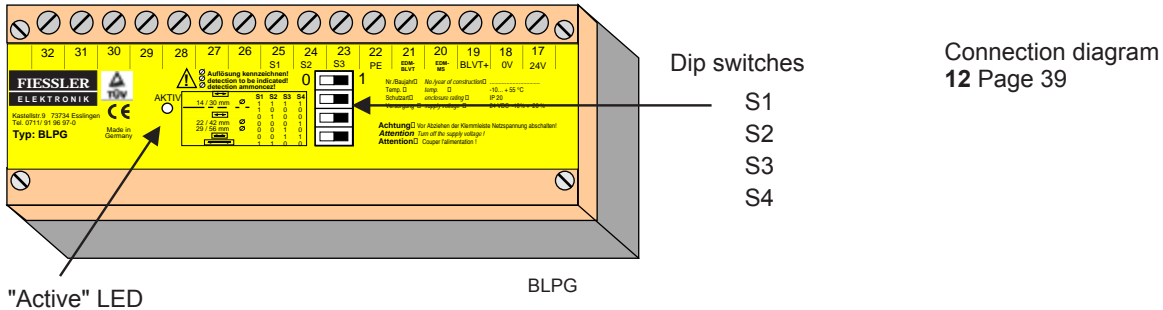

If the green LED "Aktiv" is flashing, this indicates a wrong switching position of the DIP switches or a wrong connection at the selector switch connection terminals.

Teach-in process:

1. Set the desired beam-blanking function with the dip switches of the PLSG3P.
2. Position the barriers to be blanked out in the protective field.
The first beam (as seen from the plug) must not be dark during teach-in. Otherwise the light grid assumes the error state and the orange and yellow LEDs on the receiver start to flash rapidly (about 4 times per second).
3. Actuate the key switch for at least 2 seconds until the "Active" LED comes on.
4. Release the key switch.
5. The blanking mode of the BLVT light grid is displayed. When the "Active" LED goes off, it means that programming is complete, and the red and orange LEDs of the light grid's receiver come on.
6. The light grid is now ready for operation. The green LED on the light grid's receiver comes on.

The operating modes dynamic blanking as well as 1-beam and 2-beam reduced resolution are indicated on the receiver by slow flashing (approximately once / second) of the "Adjustment aid and restart interlock" LEDs.

| blanking modes: | Dip switches | | | |
|---|--------------|----|----|----|
| | S1 | S2 | S3 | S4 |
| No blanking | 1 | 1 | 1 | 1 |
| Static blanking | 1 | 0 | 0 | 0 |
| Static blanking with 1-beam reduced resolution | 1 | 0 | 0 | 1 |
| Static blanking with 1-beam reduced resolution | 1 | 0 | 1 | 0 |
| Dynamic blanking (nur 1 Bereich möglich) | 0 | 1 | 0 | 0 |
| Dynamic blanking with 1-beam reduced resolution | 0 | 1 | 0 | 1 |
| Dynamic blanking with 2-beam reduced resolution | 0 | 1 | 1 | 0 |
| 1-beam reduced resolution | 0 | 0 | 0 | 1 |
| 2-beam reduced resolution | 0 | 0 | 1 | 0 |
| Only ignore 1 beam once | 0 | 0 | 1 | 1 |
| Only ignore 2 beam once | 1 | 1 | 0 | 0 |

When operating the BLVT, the protective field must be tested with the test rod as indicated in the instruction manual after re-programming or switching. At any point in the remaining protective field, this rod must lead to deactivation. Observe the BLVT operating manual.

3.5.1 Switchover between up to 5 operating modes

Up to 5 operating modes can be stored in the PLSG3. An external selector switch can be used to change between the saved operating modes.
During cyclic control, for example, changeover is possible between various work cycles and/or cycle time monitoring modes, or operating modes without cycle control.

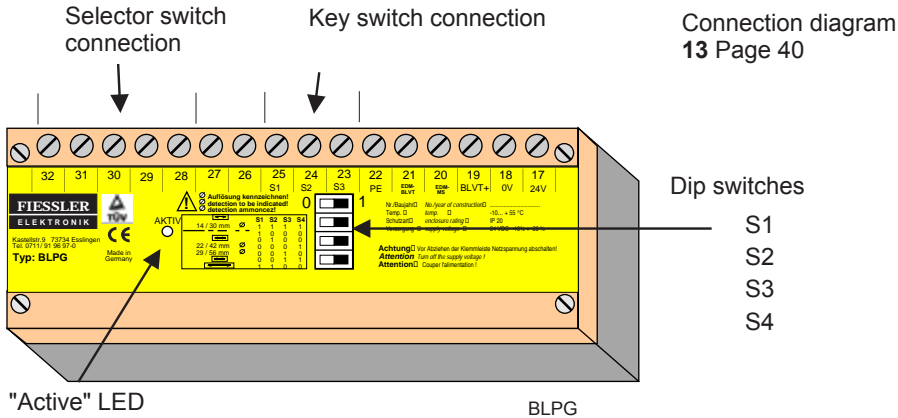

If the green LED "Aktiv" is flashing, this indicates a wrong switching position of the DIP switches or a wrong connection at the selector switch connection terminals.

Storage of operating modes in the PLSG3:

1. Use the hex switches to set the PLSG3 to the desired operating mode (refer to Chapter 6 on operating-mode tables).
 2. Set all dip switches to 0.
 3. Move the selector switch to the setting to be assigned to the PLSG3 operating mode.
 4. Actuate the key switch for at least 2 seconds until the "Active" LED comes on.
 5. Release the key switch.
 6. The LCD displays **"Mode // assigned"** and the selector switch setting (for example, **"Switch // mode 1"**).
- Repeat steps 1 - 6 for each required selector switch setting.

Example:

| | Hex switch 1 2 3 4 | Dip switch S1 S2 S3 S4 | selector switch | key switch |
|---|-----------------------|---------------------------|-----------------|--------------------|
| 1 Cycle control with restart interlock, with contactor control | E E 0 0 | 0 0 0 0 | 1 | actuate for 2 sec. |
| 2 Cycle control with restart interlock, with contactor control | E E 1 1 | 0 0 0 0 | 2 | actuate for 2 sec. |
| 3 Cycle control with restart interlock, with contactor control | E E 2 2 | 0 0 0 0 | 3 | actuate for 2 sec. |
| Muting mode with restart interlock, with contactor control | 8 8 0 0 | 0 0 0 0 | 4 | actuate for 2 sec. |
| Safety mode with restart interlock, with contactor control | C C 0 0 | 0 0 0 0 | 5 | actuate for 2 sec. |

Preparing for switching between operating modes

1. Move the hex switches to the setting "selector switch operation without blanking assignment" (= FF DD).
2. Set all dip switches to 0.

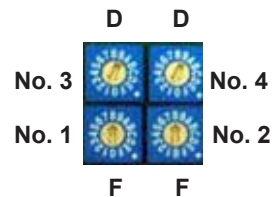

Activation of the current selector switch setting / switchover between stored operating modes:
(To complete storage, perform the following step once (activation of the current selector switch setting))

1. Move the selector switch to the setting assigned to the desired operating mode.
2. Actuate the key switch for at least 2 seconds until the "Active" LED comes on.
3. Release the key switch.

3.5.2 Switchover between up to 5 operating modes and up to 5 beam blanking functions in the light grid

Up to 5 operating modes can be stored in the PLSG3, simultaneously with up to 5 blanking functions in the BLVT light grid. An external selector switch can be used to change between the saved operating modes and blanking functions of the BLVT, so that each selector switch setting can be assigned to a different PLSG3 operating mode and beam-blanking function. Assignments between BLVT blanking functions and the selector switch can also be de-selected, permitting retention of the BLVT blanking functions on switchover of the PLSG3 operating mode.

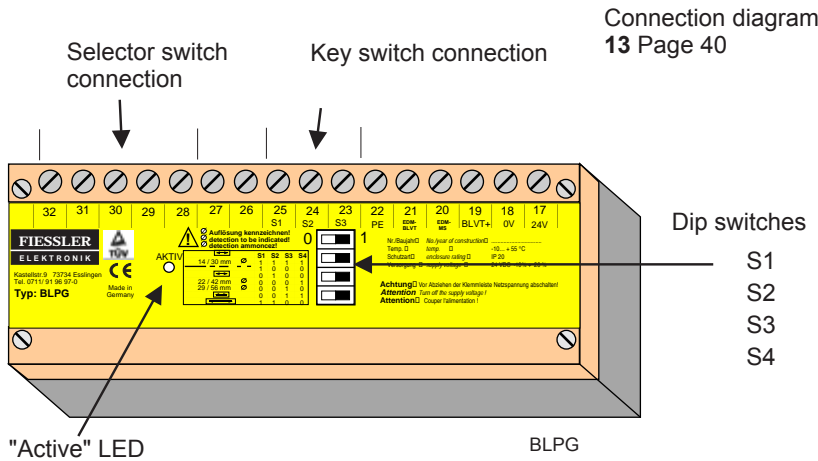

If the green LED "Aktiv" is flashing, this indicates a wrong switching position of the DIP switches or a wrong connection at the selector switch connection terminals.

| blanking modes: | Dip switches | | | |
|---|--------------|----|----|----|
| | S1 | S2 | S3 | S4 |
| No blanking | 1 | 1 | 1 | 1 |
| Static blanking | 1 | 0 | 0 | 0 |
| Static blanking with 1-beam reduced resolution | 1 | 0 | 0 | 1 |
| Static blanking with 1-beam reduced resolution | 1 | 0 | 1 | 0 |
| Dynamic blanking (nur 1 Bereich möglich) | 0 | 1 | 0 | 0 |
| Dynamic blanking with 1-beam reduced resolution | 0 | 1 | 0 | 1 |
| Dynamic blanking with 2-beam reduced resolution | 0 | 1 | 1 | 0 |
| 1-beam reduced resolution | 0 | 0 | 0 | 1 |
| 2-beam reduced resolution | 0 | 0 | 1 | 0 |
| Only ignore 1 beam once | 0 | 0 | 1 | 1 |
| Only ignore 2 beam once | 1 | 1 | 0 | 0 |

Storage of operating modes and beam blanking:

1. Use the hex switches to set the required PLSG operating mode.
2. Use the dip switches to set the required BLVT blanking mode.
3. Move the selector switch to the setting to be assigned to the PLSG operating mode and blanking function.
4. Position the barriers to be blanked in the protective field.
The first beam (as seen from the plug) must not be dark during teach-in. Otherwise the light grid assumes the error state, and the orange and yellow LEDs on the receiver flash rapidly (approximately 4 times / second).
5. Actuate the key switch for at least 2 seconds until the "Active" LED comes on.
6. Release the key switch.
7. The LCD displays the BLVT blanking mode, and the red and orange LEDs of the BLVT light grid come on.
8. The LCD displays **(mode // assigned)** and the selector switch setting (for example, **switch // mode 1**). The green LED on the BLVT comes on; depending on the blanking mode, the yellow and orange LEDs flash.

Repeat steps 1 - 8 for each required selector switch setting.

Example: see next page

Preparing for switching between operating modes:

1. Move the hex switches to the setting "selector switch operation with blanking assignment" (= **FF EE**).
2. Set all dip switches to 0.

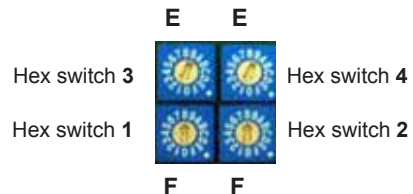

Switching between stored operating modes / blanking functions:

1. Move the selector switch to the setting assigned to the required operating mode.
2. Actuate the key switch for at least 2 seconds until the "Active" LED comes on.
3. Release the key switch

During operation with the BLVT, the protective field must be tested with the test rod after re-programming or switching. At any point in the remaining protective field, this rod must lead to deactivation. Observe the BLVT operating manual.

3.5.2 Switchover between up to 5 operating modes and up to 5 beam blanking functions in the light grid

Example:



1. Storage of operating modes and beam blanking:

| Hex switch | Dip switch | selector switch | key switch |
|---|--------------------------------|-----------------|--------------------|
| 1 2 3 4 | S1 S2 S3 S4 | | |
| E E 0 0 | 1 1 1 1 | 1 | actuate for 2 sec. |
| 1 Cycle control with restart interlock, with contactor control | No blanking | | |
| E E 1 1 | 1 1 1 1 | 2 | actuate for 2 sec. |
| 2 Cycle control with restart interlock, with contactor control | No blanking | | |
| 8 8 0 0 | 1 1 1 1 | 3 | actuate for 2 sec. |
| Muting mode with restart interlock, with contactor control | No blanking | | |
| C C 0 0 | 0 0 1 1 | 4 | actuate for 2 sec. |
| Safety mode with restart interlock, with contactor control | Only ignore 1 beam once | | |
| C C 0 0 | 1 0 0 0 | 5 | actuate for 2 sec. |
| Safety mode with restart interlock, with contactor control | Static blanking | | |

2. Preparing for switching between operating modes:

| Hex switch | Dip switch |
|---|-------------|
| 1 2 3 4 | S1 S2 S3 S4 |
| F F E E | 0 0 0 0 |
| selector switch operation with blanking assignment | |

3. Switching between stored operating modes / blanking functions::

| selector switch | key switch | Operation mode / blanking mode |
|-----------------|--------------------|---|
| 1 | actuate for 2 sec. | 1 Cycle control with restart interlock, with contactor control, no blanking |
| 2 | actuate for 2 sec. | 2 Cycle control with restart interlock, with contactor control, no blanking |
| 3 | actuate for 2 sec. | Muting mode with restart interlock, with contactor control, no blanking |
| 4 | actuate for 2 sec. | Safety mode with restart interlock, with contactor control, only ignore 1 beam once |
| 5 | actuate for 2 sec. | Safety mode with restart interlock, with contactor control, Static blanking |

4.1 Setting and storage of muting time limits (max. muting time). Also refer to Chapter 3.1.3.

The operator can limiting the muting time on the PLSG2 & PLSG3. The time period begins as soon as one muting sensor switches into the muted state, and ends as soon as all sensors are in the non-muted state. This period should be set to the shortest possible value permitted by the nature of the application, in order to maximize manipulation safety and optimize fault detection on the muting sensors. To ensure proper functionality of the system, however, the muting time limit should be sufficient to prevent the maximum muting time from being exceeded given the slowest flow of material and the longest material items.

If the distance between the conveyed material items can be smaller than the distance between the muting sensors which are remotest from each other (t_2), the muting time runs on until the gap between the material items is large enough again to disable all muting sensors simultaneously (t_3). In this case, the muting time limit must be set such that it is longer by t_2 than the time needed between two larger gaps (t_1).

Minimum muting time = $t_1 + t_2$

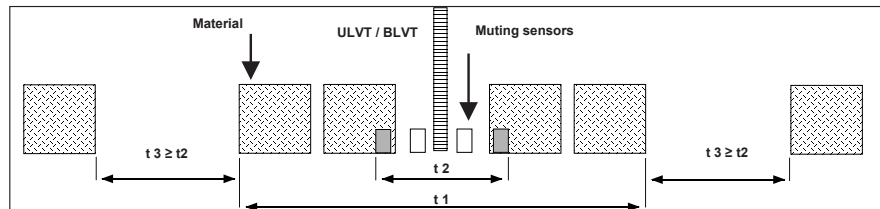

The muting time limit is set by actuating the start button in accordance with the plain text instructions displayed by the PLSG2 / -3.

To change between menus, briefly press the start button; to confirm the display, keep the button held down until the "release button" prompt appears (after about 2 seconds).

Example : The muting time limit is to be raised from 30 s to 50 s :

1. Turn off the supply voltage.
2. Press the start button.
3. Keep the start button pressed. Turn on the supply voltage.
4. Keep the start button pressed. Plain text display: "TEACH-IN TIME".
5. Keep the start button pressed. Plain text display: "RELEASE BUTTON".
6. Release the start button.
7. Plain text display: "MAX: MUTE TIME".
8. Press the start button.
9. Keep the start button pressed. Plain text display: "RELEASE BUTTON".
10. Release the start button.
11. Plain text display: "MUTE TIME 30 SEC." The set muting time limit is indicated.
12. Press the start button briefly and release it again. This increments the time until the start button is actuated again.
13. Plain text display: "MUTE TIME 31 SEC."
14. Plain text display: "MUTE TIME 32 SEC."
15. Plain text display: "MUTE TIME 33 SEC."
16. .
17.
31. Plain text display: "MUTE TIME 49 SEC."
32. Plain text display: "MUTE TIME 50 SEC."
33. Plain text display: "MUTE TIME 51 SEC." No check was made as to whether the 50 s were overshoot. For this reason:
34. Press the start button briefly and release it again. This decrements the time until the start button is actuated again.
35. Plain text display: "MUTE TIME 50 SEC."
36. Press the start button.
37. Keep the start button pressed. Plain text display: "STORED 50 SEC."
38. Keep the start button pressed. Plain text display: "RELEASE BUTTON"
39. Release the start button
40. Plain text display: "MAX. MUTE TIME ". If the time needs to be readjusted, proceed again from step 8.
41. Press the start button briefly and release it again.
42. Plain text display: "MUTE OFF DELAY". This message appears only if the set operating mode permits delays in end of muting. In this case, the delay time can be set here as described in the next chapter.
43. Press the start button briefly and release it again
44. Plain text display: "EXIT TEACH"
45. Press the start button.
46. Keep the start button pressed. Plain text display: "RELEASE BUTTON"
47. Release the start button

The setting procedure is complete.

The PLSG2/3 is delivered with a default muting time limit of 30 seconds.

The settings are only effective during use of the muting function.

If the function "Immediate end of muting when the protective field is clear again" has been selected, there is no muting time limit.

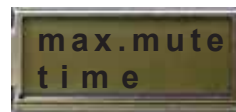

4.2 Setting and storing end of muting delay

The delayed end of muting period starts as soon as the conveyed material has left the range of the muting sensors, so that they no longer produce the muting state. **The delayed end of muting period must be set to the shortest possible value** to enable cancellation of the muting state as soon as the conveyed material has left the protective field. However, this period should be sufficiently long to cover the time needed for the material to be conveyed from clearing of the muting sensor located farthest from the protective field until renewed clearing of the protective field at the slowest possible conveyor speed. If the conveying speed varies very much, an operating mode comprising the combination "delayed end of muting period + end of muting as soon as the protective field is free" should be selected.

The delayed end of muting period must be set to 0 seconds if the muting sensors are installed in front of the protective field outside the hazard zone (refer to Chapters 3.1.9 and 3.1.11)

Delayed end of muting is set by actuating the start button according to the plain text instructions output by the PLSG2 / 3.

To change over between menus, briefly press the start button; to confirm the display, keep the button held down until the "release button" prompt appears.

Example: The end of muting delay is to be lengthened from 0s to 20s:

1. Turn off the supply voltage.
2. Press the start button.
3. Keep the start button pressed. Turn on the supply voltage.
4. Keep the start button pressed. Plain text display: "TEACH TIME"
5. Keep the start button pressed. Plain text display: "RELEASE BUTTON"
6. Release the start button.
7. Plain text display: "MAX: MUTE TIME". The muting time can be set here as described in the previous chapter.
8. Press the start button briefly and release it again
9. Plain text display: "MUTING OFF DELAY"
10. Press the start button.
11. Keep the start button pressed. Plain text display: "RELEASE BUTTON"
12. Release the start button.
13. Plain text display: "OFF DELAY 0 SEC." The set end of muting delay is indicated.
14. Press the start button briefly and release it again. This increments the time until the start button is actuated again.
15. Plain text display: "OFF DELAY 1 SEC."
16. Plain text display: "OFF DELAY 2 SEC."
17. Plain text display: "OFF DELAY 3 SEC."
18. . . .
19. . . .
34. Plain text display: "OFF DELAY 19 SEC."
35. Plain text display: "OFF DELAY 20 SEC."
36. Plain text display: "OFF DELAY 21 SEC." No check was made as to whether the 20 s were overshoot.
For this reason:
37. Press the start button briefly and release it again. This decrements the time until the start button is actuated again.
38. Plain text display: "OFF DELAY 20 SEC."
39. Press the start button.
40. Keep the start button pressed. Plain text display: "STORED 20 SEC."
41. Keep the start button pressed. Plain text display: "RELEASE BUTTON"
42. Release the start button.
43. Plain text display: "MAX. MUTE TIME ". The muting time limit can be set here as described in the previous chapter.
44. Press the start button briefly and release it again
45. Plain text display: "MUTE OFF DELAY". If the time needs to be readjusted, proceed again from step 10.
46. Press the start button briefly and release it again
47. Plain text display: "EXIT TEACH"
48. Press the start button.
49. Keep the start button pressed. Plain text display: "RELEASE BUTTON"
50. Release the start button.



By default, the PLSG2/3 has the delayed end of muting set to 0 seconds.
The setting is only effective during use of the muting function with delayed end of muting.

The setting procedure is complete.

To change the display language, move the hex switch to the corresponding setting, turn off the supply voltage and turn it on again.

After the display language has been changed, turn off the voltage, set the required operating mode (refer to Chapter 6 on operating-mode tables) and turn on the voltage again.

Hex switch



Changing and saving the display language

| | |
|--------------|---------|
| 12 34 | |
| FF BB | German |
| FF CC | English |



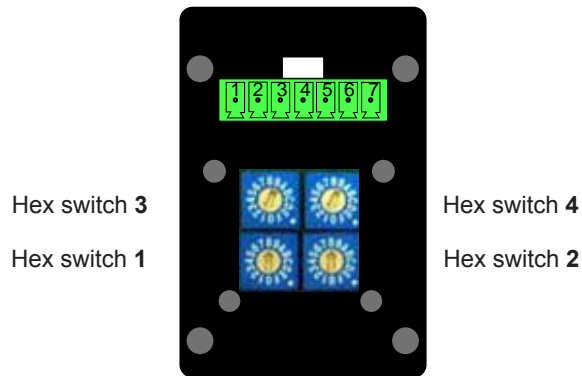

Hex switches 1 - 4 are used to set the desired operating modes.
 To adjust these hex switches, it is necessary to remove the connection cover.

IMPORTANT:

Perform these settings with the PLSG de-energized.

To ensure error-free operation, set an operating mode suitable for the application and observe the relevant connection diagrams.

Also observe Chapter 6.2 (procedure for setting operating modes) and Chapter 7.3 (relevant connection diagrams).

1. Ascertaining functions with the selection aid (next page) and determining operating mode tables

The **selection aid** ... shows all possible combinations of functions and corresponding tables of operating modes.

Chapter 3 provides important notes on the various functions.

Example: (PLSG3)

- **with** restart interlock
- **with** contactor and valve control
- Muting mode
- immediate end of muting when the protective field is clear again
- connection of an emergency-stop switch

Determined mode table 1 on Page 22

| Functions | Function possible | | No. Operating mode table | | | | | |
|---|-------------------|-------|--------------------------|------------|------------|------------|------------|------------|
| | PLSG2 | PLSG3 | 1 p. 22 | 2 p. 23 | 3 p. 24 | 4 p. 24 | 5 p. 25 | 6 p. 26 |
| With restart interlock Start of hazardous movement possible only with manual acknowledgement (start button). | X | X | ● | - | - | ● | ● | ● |
| Without restart interlock Start of hazardous movement possible without command initiation. | X | X | - | ● | - | - | - | - |
| With restart interlock only during hazardous movement For cyclic infiltration of the protective field during non-hazardous movement or at a standstill, without subsequent command initiation for starting. | - | X | - | - | ● | - | - | - |
| Contactor and valve control (EDM) Control of subsequent switching elements | X | X | ○ | ○ | ● | ○ | ○ | ○ |
| Muting (bypass) If material is conveyed through the protective field, or if manufacturing conditions prevent stop on interruption of the protective field in a segment of the work cycle. | X | X | ○ | X | X | - | - | X |
| Stoppage of muting time limitation Prevents unwanted deactivation in case of material accumulation. | X | X | X | X | X | - | - | - |
| Override Enables start after unscheduled stop in a muted state (for example, belt standstill) | X | X | X | X | X | - | - | - |
| Muting with 4 sensors The conveyed material is scanned by 4 sensors. | X | X | X | X | X | - | - | - |
| Muting with 2 sensors The conveyed material is scanned 2 sensors.. | X | X | X | X | X | - | - | X |
| Delayed end of muting Manipulation-proof muting if conveyed material flow only exits the hazardous zone. | X | X | ○ | ○ | ○ | - | - | - |
| Immediate end of muting when protective field is cleared again The muted state persists only as long as absolutely necessary | X | X | ○ | ○ | ○ | - | - | - |
| 2-stage output deactivation Output OSSD2 switches off with a delay of 0.5 s. OSSD1 switches off immediately. For safety-critical control drives, e.g. robot safeguarding. | X | X | ○ | ○ | ○ | - | ○ | - |
| Emergency-stop circuit monitoring Monitoring of guard doors, emergency-stop switches etc. | - | X | ○ | ○ | ○ | ● | - | ○ |
| Two-hand start Prevention of inadvertent starting in hazard zones, e.g. passable press areas. | - | X | ○ | ○ | - | ● | - | - |
| External displays for start and protective field status Optional connection | - | X | - | - | ○ | - | ○ | ○ |
| Cycle control (1 - 4 work cycles, e.g. for insertion operations) Machine control via the operator's work patterns. | - | X | - | - | - | - | - | ● |

Selection aiding table ... on the next page

- Function can be de-selected
- Function cannot be de-selected
- × Function is not necessary
- Function is not available

2. Reading and setting operating modes

From the **table** determined for the **selected operating mode**, read the corresponding **hex switch position** and set it on the PLSG... (observe the correct order of the hex switches)

| Hex switch | | 6.3 Muting mode with restart interlock (also refer to Chapter 3.2.3) | | | | | | Table 1 | |
|------------|---|---|--------------------------------------|--|----------------------------------|--|---|-----------------------------------|---------|
| 3 | 4 | Muting time limit ⁶ | End of muting delay ¹ | End of muting with the protective field clear ² | OSSD2 cut off delay ³ | Emergency-stop circuit (only 2 muting sensors) | Two-hand start ⁵ (only 2 muting sensors) | Corresponding connection diagrams | |
| 1 | 2 | Obs. Chapters 3.1.3 and 4.1! | Obs. Chapters 3.1.9, 3.1.11 and 4.2! | Obs. Chapters 3.1.10 and 3.1.11! | Obs. Chapter 3.2.1! | Obs. Chapter 3.2.2! | Obs. Chapter 3.2.5! | Must | Option |
| 12 34 | | Without contactor control (observe Chapter 3.2.6) | | | | | | Must | Option |
| 00 00 | | ● (1 - 253s / 1h) | - | - | - | - | - | 2, 12 | 6, 7, 8 |
| 00 11 | | ● (1 - 253s / 1h) | - | - | - | ● (only PLSG3) | - | 2, 4, 12 | 7, 8 |

Excerpt from operating mode table 1 on Page 22

| | | | | | | | | | |
|-------|---|--------------|---|---|----------------|----------------|----------------|-------------|-------|
| 00 FF | - | ● (1 - 195s) | ● | - | - | - | ● (only PLSG3) | 3, 12 | 7, 8 |
| 12 34 | With contactor control (observe Chapter 3.2.6) | | | | | | Must | Option | |
| 88 00 | ● (1 - 253s / 1h) | - | - | - | - | - | - | 1, 2, 12 | 6, 7, |
| 88 11 | ● (1 - 253s / 1h) | - | - | - | ● (only PLSG3) | - | - | 1, 2, 4, 12 | 7, 8 |
| 88 22 | ● (1 - 253s / 1h) | - | - | - | ● | - | - | 1, 2, 5, 12 | 6, 7, |
| 88 33 | ● (1 - 253s / 1h) | - | - | - | - | - | ● (only PLSG3) | 1, 3, 12 | 7, 8 |
| 88 44 | - | - | - | - | - | - | - | 1, 2, 12 | 6, 7, |
| 88 55 | - | - | ● | - | - | ● (only PLSG3) | - | 1, 2, 4, 12 | 7, 8 |
| 88 66 | - | - | ● | - | ● | - | - | 1, 2, 5, 12 | 6, 7, |
| 88 77 | - | - | - | - | - | - | - | 1, 3, 12 | 7, 8 |

Hex switch setting determined for the example above: **88 55**

1. Select the functions

2. Ascertain the operating mode table

| Functions | Function possible | | No. Operating mode table / Page | | | | | |
|--|-------------------|--------|---------------------------------|------------|------------|------------|------------|------------|
| | PLSG2K | PLSG3K | 1 p. 22 | 2 p. 23 | 3 p. 24 | 4 p. 24 | 5 p. 25 | 6 p. 26 |
| With restart interlock Start of hazardous movement possible only with manual acknowledgement (start button). | X | X | ● | - | - | ● | ● | ● |
| Without restart interlock Start of hazardous movement possible without command initiation | X | X | - | ● | - | - | - | - |
| With restart interlock only during hazardous movement For cyclic infiltration of the protective field during non-hazardous movement or at a standstill, without subsequent command initiation for starting. | - | X | - | - | ● | - | - | - |
| Contactor and valve control (EDM) Control of subsequent switching elements | X | X | ○ | ○ | ● | ○ | ○ | ○ |
| Muting (bypass) If material is conveyed through the protective field, or if manufacturing conditions prevent stop on interruption of the protective field in a segment of the work cycle. | X | X | X | X | X | - | - | X |
| Stoppage of muting time limitation Prevents unwanted deactivation in case of material accumulation. | X | X | X | X | X | - | - | - |
| Override Enables start after unscheduled stop in a muted state (for example, belt standstill) | X | X | X | X | X | - | - | - |
| Muting with 4 sensors The conveyed material is scanned by 4 sensors. | X | X | X | X | X | - | - | - |
| Muting with 2 sensors The conveyed material is scanned 2 sensors. | X | X | X | X | X | - | - | X |
| Delayed end of muting Manipulation-proof muting if conveyed material flow only exits the hazardous zone. | X | X | ○ | ○ | ○ | - | - | - |
| Immediate end of muting when protective field is cleared again The muted state persists only as long as absolutely necessary | X | X | ○ | ○ | ○ | - | - | - |
| 2-stage output deactivation Output OSSD2 switches off with a delay of 0.5 s. OSSD1 switches off immediately. For safety-critical control drives, e.g. robot safeguarding. | X | X | ○ | ○ | ○ | - | ○ | - |
| Emergency-stop circuit monitoring Monitoring of guard doors, emergency-stop switches etc. | - | X | ○ | ○ | ○ | ● | - | ○ |
| Two-hand start Prevention of inadvertent starting in hazard zones, e.g. passable press areas. | - | X | ○ | ○ | - | ● | - | - |
| External displays for start and protective field status Optional connection | - | X | - | - | ○ | - | ○ | ○ |
| Cycle control (1 - 4 work cycles, e.g. for insertion operations) Machine control via the operator's work patterns. | - | X | - | - | - | - | - | ● |

○ Function can be de-selected

● Function **cannot** be de-selected

✕ Function is not necessary

- Function is not available

Operating mode tables

Hex switch



6.3 Muting mode with restart interlock (also refer to Chapter 3.2.3)

Table 1

| | | Muting time limit ⁶ | End of muting delay ¹ | End of muting with the protective field clear ² | OSSD2 cut off delay ³ | Emergency-stop circuit ⁴ (only 2 muting sensors) | Two-hand start ⁵ (only 2 muting sensors) | Corresponding connection diagrams | |
|--------------|--|--------------------------------|--------------------------------------|--|----------------------------------|---|---|-----------------------------------|---------------|
| | | Obs. Chapters 3.1.3 and 4.1! | Obs. Chapters 3.1.9, 3.1.11 and 4.2! | Obs. Chapters 3.1.10 and 3.1.11! | Obs. Chapter 3.2.1! | Obs. Chapter 3.2.2! | Obs. Chapter 3.2.5! | Must | Option |
| 12 34 | Without contactor control (observe Chapter 3.2.6) | | | | | | | Must | Option |
| 00 00 | ● (1 - 253s / 1h) | - | - | - | - | - | - | 2 | 6, 7, 8 |
| 00 11 | ● (1 - 253s / 1h) | - | - | - | - | ● (only PLSG3) | - | 2, 4 | 7, 8 |
| 00 22 | ● (1 - 253s / 1h) | - | - | - | ● | - | - | 2, 5 | 6, 7, 8 |
| 00 33 | ● (1 - 253s / 1h) | - | - | - | - | - | ● (only PLSG3) | 3 | 7, 8 |
| 00 44 | - | - | ● | - | - | - | - | 2 | 6, 7, 8 |
| 00 55 | - | - | ● | - | - | ● (only PLSG3) | - | 2, 4 | 7, 8 |
| 00 66 | - | - | ● | ● | ● | - | - | 2, 5 | 6, 7, 8 |
| 00 77 | - | - | ● | - | - | - | ● (only PLSG3) | 3 | 7, 8 |
| 00 88 | ● (1 - 253s / 1h) | ● (0 - 30s) | - | - | - | - | - | 2 | 6, 7, 8 |
| 00 99 | ● (1 - 253s / 1h) | ● (0 - 30s) | - | - | - | ● (only PLSG3) | - | 2, 4 | 7, 8 |
| 00 AA | ● (1 - 253s / 1h) | ● (0 - 30s) | - | - | ● | - | - | 2, 5 | 6, 7, 8 |
| 00 BB | ● (1 - 253s / 1h) | ● (0 - 30s) | - | - | - | - | ● (only PLSG3) | 3 | 7, 8 |
| 00 CC | - | ● (0 - 195s) | ● | - | - | - | - | 2 | 6, 7, 8 |
| 00 DD | - | ● (0 - 195s) | ● | - | - | ● (only PLSG3) | - | 2, 4 | 7, 8 |
| 00 EE | - | ● (0 - 195s) | ● | ● | ● | - | - | 2, 5 | 6, 7, 8 |
| 00 FF | - | ● (0 - 195s) | ● | - | - | - | ● (only PLSG3) | 3 | 7, 8 |
| 12 34 | With contactor control (observe Chapter 3.2.6) | | | | | | | Must | Option |
| 88 00 | ● (1 - 253s / 1h) | - | - | - | - | - | - | 1, 2 | 6, 7, 8 |
| 88 11 | ● (1 - 253s / 1h) | - | - | - | - | ● (only PLSG3) | - | 1, 2, 4 | 7, 8 |
| 88 22 | ● (1 - 253s / 1h) | - | - | - | ● | - | - | 1, 2, 5 | 6, 7, 8 |
| 88 33 | ● (1 - 253s / 1h) | - | - | - | - | - | ● (only PLSG3) | 1, 3 | 7, 8 |
| 88 44 | - | - | ● | - | - | - | - | 1, 2 | 6, 7, 8 |
| 88 55 | - | - | ● | - | - | ● (only PLSG3) | - | 1, 2, 4 | 7, 8 |
| 88 66 | - | - | ● | ● | ● | - | - | 1, 2, 5 | 6, 7, 8 |
| 88 77 | - | - | ● | - | - | - | ● (only PLSG3) | 1, 3 | 7, 8 |
| 88 88 | ● (1 - 253s / 1h) | ● (0 - 30s) | - | - | - | - | - | 1, 2 | 6, 7, 8 |
| 88 99 | ● (1 - 253s / 1h) | ● (0 - 30s) | - | - | - | ● (only PLSG3) | - | 1, 2, 4 | 7, 8 |
| 88 AA | ● (1 - 253s / 1h) | ● (0 - 30s) | - | - | ● | - | - | 1, 2, 5 | 6, 7, 8 |
| 88 BB | ● (1 - 253s / 1h) | ● (0 - 30s) | - | - | - | - | ● (only PLSG3) | 1, 3 | 7, 8 |
| 88 CC | - | ● (0 - 195s) | ● | - | - | - | - | 1, 2 | 6, 7, 8 |
| 88 DD | - | ● (0 - 195s) | ● | - | - | ● (only PLSG3) | - | 1, 2, 4 | 7, 8 |
| 88 EE | - | ● (0 - 195s) | ● | ● | ● | - | - | 1, 2, 5 | 6, 7, 8 |
| 88 FF | - | ● (0 - 195s) | ● | - | - | - | ● (only PLSG3) | 1, 3 | 7, 8 |

1 After deactivation of the muting sensors, the muted state persists until the muting termination delay is over.

2 Irrespective of the muting sensors' states, the muted state is ended as soon as the xLVT releases its OSSDs again; renewed muting is only possible once all muting sensors have been deactivated.

3 OSSD2 cuts out with a delay of approximately 0.5 s.

4 A two-channel emergency-stop circuit with a normally closed function is monitored at 1A and 2A; 1B and 2B are available for connecting 2 muting sensors.

5 The restart interlock is active, the OSSDs can only be released again through simultaneous actuation of a NO contact at 1A and a NC contact at 2A.

6 The muting time limiter sets the muting time to an adjustable value between 1 s and 253 s, or to a value of 1 hour.

Operating mode tables

Hex switch



6.4 Muting mode without restart interlock also refer to Chapter 3.2.3)

Table 2

| | Muting time limit ⁶ | End of muting delay ¹ | End of muting with the protective field clear ² | OSSD2 cut off delay ³ | Emergency-stop circuit ⁴ (only 2 muting sensors) | Corresponding connection diagrams | |
|--------------|---|-------------------------------------|--|----------------------------------|--|-----------------------------------|---------------|
| | Obs. chapter 3.1.3 and 4.1! | Obs. chapter 3.1.9, 3.1.11 and 4.2! | Obs. chapter 3.1.10 and 3.1.11! | Obs. chapter 3.2.1! | Obs. chapter 3.2.2! | | |
| 12 34 | <u>Without</u> contactor control (observe Chapter 3.2.6) | | | | | Must | Option |
| 33 00 | ● (1 - 253s / 1h) | - | - | - | - | - | 2, 6, 7, 8 |
| 33 11 | ● (1 - 253s / 1h) | - | - | - | ● (Only PLSG3) | 4 | 2, 7, 8 |
| 33 22 | ● (1 - 253s / 1h) | - | - | ● | - | 5 | 2, 6, 7, 8 |
| 33 33 | ● (1 - 253s / 1h) | - | - | ● | ● (Only PLSG3) | 4, 5 | 2, 7, 8 |
| 33 44 | - | - | ● | - | - | - | 2, 6, 7, 8 |
| 33 55 | - | - | ● | - | ● (Only PLSG3) | 4 | 2, 7, 8 |
| 33 66 | - | - | ● | ● | - | 5 | 2, 6, 7, 8 |
| 33 77 | - | - | ● | ● | ● (Only PLSG3) | 4, 5 | 2, 7, 8 |
| 33 88 | ● (1 - 253s / 1h) | ● (0 - 30s) | - | - | - | - | 2, 6, 7, 8 |
| 33 99 | ● (1 - 253s / 1h) | ● (0 - 30s) | - | - | ● (Only PLSG3) | 4 | 2, 7, 8 |
| 33 AA | ● (1 - 253s / 1h) | ● (0 - 30s) | - | ● | - | 5 | 2, 6, 7, 8 |
| 33 BB | ● (1 - 253s / 1h) | ● (0 - 30s) | - | ● | ● (Only PLSG3) | 4, 5 | 2, 7, 8 |
| 33 CC | - | ● (0 - 195s) | ● | - | - | - | 2, 6, 7, 8 |
| 33 DD | - | ● (0 - 195s) | ● | - | ● (Only PLSG3) | 4 | 2, 7, 8 |
| 33 EE | - | ● (0 - 195s) | ● | ● | - | 5 | 2, 6, 7, 8 |
| 33 FF | - | ● (0 - 195s) | ● | ● | ● (Only PLSG3) | 4, 5 | 2, 7, 8 |
| 12 34 | <u>With</u> contactor control (observe Chapter 3.2.6) | | | | | Must | Option |
| BB 00 | ● (1 - 253s / 1h) | - | - | - | - | 1 | 2, 6, 7, 8 |
| BB 11 | ● (1 - 253s / 1h) | - | - | - | ● (Only PLSG3) | 1, 4 | 2, 7, 8 |
| BB 22 | ● (1 - 253s / 1h) | - | - | ● | - | 1, 5 | 2, 6, 7, 8 |
| BB 33 | ● (1 - 253s / 1h) | - | - | ● | ● (Only PLSG3) | 1, 4, 5 | 2, 7, 8 |
| BB 44 | - | - | ● | - | - | 1 | 2, 6, 7, 8 |
| BB 55 | - | - | ● | - | ● (Only PLSG3) | 1, 4 | 2, 7, 8 |
| BB 66 | - | - | ● | ● | - | 1, 5 | 2, 6, 7, 8 |
| BB 77 | - | - | ● | ● | ● (Only PLSG3) | 1, 4, 5 | 2, 7, 8 |
| BB 88 | ● (1 - 253s / 1h) | ● (0 - 30s) | - | - | - | 1 | 2, 6, 7, 8 |
| BB 99 | ● (1 - 253s / 1h) | ● (0 - 30s) | - | - | ● (Only PLSG3) | 1, 4 | 2, 7, 8 |
| BB AA | ● (1 - 253s / 1h) | ● (0 - 30s) | - | ● | - | 1, 5 | 2, 6, 7, 8 |
| BB BB | ● (1 - 253s / 1h) | ● (0 - 30s) | - | ● | ● (Only PLSG3) | 1, 4, 5 | 2, 7, 8 |
| BB CC | - | ● (0 - 195s) | ● | - | - | 1 | 2, 6, 7, 8 |
| BB DD | - | ● (0 - 195s) | ● | - | ● (Only PLSG3) | 1, 4 | 2, 7, 8 |
| BB EE | - | ● (0 - 195s) | ● | ● | - | 1, 5 | 2, 6, 7, 8 |
| BB FF | - | ● (0 - 195s) | ● | ● | ● (Only PLSG3) | 1, 4, 5 | 2, 7, 8 |

1 After deactivation of one or more sensors required for invoking the muted state, this state persists until the muting termination delay is over.

2 Irrespective of the muting sensors' states, the muted state is ended as soon as the XLVT releases its OSSDs again; renewed muting is only possible once all muting sensors have been deactivated.

3 OSSD2 cuts out with a delay of approximately 0.5 s.

4 A two-channel emergency-stop circuit with a normally closed function is monitored at 1A and 2A; 1B and 2B are available for connecting muting sensors.

6 The muting time limiter sets the muting time to an adjustable value between 1 s and 253 s, or to a value of 1 hour.

Hex switch



6.5 Muting mode with restart interlock only during hazardous operations (observe Chapter 3.3.1) with contactor control (observe Chapter 3.2.6)

Table 3

| | Muting time limit ⁶ | End of muting delay ¹ | End of muting with the protective field clear ² | OSSD2 cut off delay ³ | Emergency-stop circuit ⁴ (only 2 muting sensors) | External displays ⁵ for start & protective field status | Corresponding connection diagrams | |
|--------------|--------------------------------|-------------------------------------|--|----------------------------------|---|--|-----------------------------------|---------|
| | Obs. chapter 3.1.3 and 4.1! | Obs. chapter 3.1.9, 3.1.11 and 4.2! | Obs. chapter 3.1.10 and 3.1.11! | Obs. chapter 3.2.1! | Obs. chapter 3.2.2! | | Must | Option |
| 12 34 | | | | | | | | |
| DD 00 | ● (1 - 253s / 1h) | - | - | - | - | ● | 1, 2 | 7, 8, 9 |
| DD 11 | ● (1 - 253s / 1h) | - | - | - | ● (Only PLSG3) | - | 1, 2, 4 | 7, 8 |
| DD 22 | ● (1 - 253s / 1h) | - | - | ● | - | ● | 1, 2, 5 | 7, 8, 9 |
| DD 33 | ● (1 - 253s / 1h) | - | - | ● | ● (Only PLSG3) | - | 1, 2, 4, 5 | 7, 8 |
| DD 44 | - | - | ● | - | - | ● | 1, 2 | 7, 8, 9 |
| DD 55 | - | - | ● | - | ● (Only PLSG3) | - | 1, 2, 4 | 7, 8 |
| DD 66 | - | - | ● | ● | - | ● | 1, 2, 5 | 7, 8, 9 |
| DD 77 | - | - | ● | ● | ● (Only PLSG3) | - | 1, 2, 4, 5 | 7, 8 |
| DD 88 | ● (1 - 253s / 1h) | ● (0 - 30s) | - | - | - | ● | 1, 2 | 7, 8, 9 |
| DD 99 | ● (1 - 253s / 1h) | ● (0 - 30s) | - | - | ● (Only PLSG3) | - | 1, 2, 4 | 7, 8 |
| DD AA | ● (1 - 253s / 1h) | ● (0 - 30s) | - | ● | - | ● | 1, 2, 5 | 7, 8, 9 |
| DD BB | ● (1 - 253s / 1h) | ● (0 - 30s) | - | ● | ● (Only PLSG3) | - | 1, 2, 4, 5 | 7, 8 |
| DD CC | - | ● (0 - 195s) | ● | - | - | ● | 1, 2 | 7, 8, 9 |
| DD DD | - | ● (0 - 195s) | ● | - | ● (Only PLSG3) | - | 1, 2, 4 | 7, 8 |
| DD EE | - | ● (0 - 195s) | ● | ● | - | ● | 1, 2, 5 | 7, 8, 9 |
| DD FF | - | ● (0 - 195s) | ● | ● | ● (Only PLSG3) | - | 1, 2, 4, 5 | 7, 8 |

Hex switch



6.6 without muting funktions

Table 4

With restart interlock (two-hand start), emergency-stop circuit monitoring
With / without contactor control (observe Chapter 3.2.6)

| | Contactor control | Emergency-stop circuit ⁴ (only 2 muting sensors) | Two-hand start ⁷ (only 2 muting sensors) | Corresponding connection |
|--------------|---------------------|---|---|--------------------------|
| | Obs. chapter 3.2.6! | Obs. chapter 3.2.2! | Obs. chapter 3.2.5! | Must |
| 12 34 | | | | |
| 77 00 | - | ● | ● | 11 |
| FF 00 | ● | ● | ● | 1, 11 |

- 1 After deactivation of one or more sensors required for invoking the muted state, this state persists until the muting termination delay is over
- 2 Irrespective of the muting sensors' states, the muted state is ended as soon as the XLVT releases its OSSDs again; renewed muting is only possible once all muting sensors have been deactivated.
- 3 OSSD2 cuts out with a delay of approximately 0.5 s.
- 4 A two-channel emergency-stop circuit with a normally closed function is monitored at 1A and 2A; 1B and 2B are available for connecting muting sensors.
- 5 Terminals 1A and 2A can be used for connecting external indicators of the protective field's state and starting units; refer to connection diagram 9.
- 6 The muting time limiter sets the muting time to an adjustable value between 1 s and 253 s, or to a value of 1 hour.
- 7 If the restart interlock is active, the OSSDs can only be released again through simultaneous actuation of a NO contact at 1B and a NC contact at 2B.

Operating mode tables

Hex switch



6.7 Without muting functions / with restart interlock (observe Chapter 3.2.3) **Table 5**

| | | OSSD2 cut off delay ¹ | External displays ² for start & protective field status | Corresponding connection diagrams | |
|-----------|-----------|--|--|-----------------------------------|---------------|
| | | Obs. chapter 3.2.1! | | | |
| 12 | 34 | Without contactor control (observe Chapter 3.2.6) | | Must | Option |
| 44 | 00 | - | ● | 2 | 9 |
| 44 | 11 | - | ● | 2 | 9 |
| 44 | 22 | - | ● | 2 | 9 |
| 44 | 33 | - | ● | 2 | 9 |
| 44 | 44 | - | ● | 2 | 9 |
| 44 | 55 | - | ● | 2 | 9 |
| 44 | 66 | - | ● | 2 | 9 |
| 44 | 77 | - | ● | 2 | 9 |
| 44 | 88 | ● | ● | 2, 5 | 9 |
| 44 | 99 | ● | ● | 2, 5 | 9 |
| 44 | AA | ● | ● | 2, 5 | 9 |
| 44 | BB | ● | ● | 2, 5 | 9 |
| 44 | CC | ● | ● | 2, 5 | 9 |
| 44 | DD | ● | ● | 2, 5 | 9 |
| 44 | EE | ● | ● | 2, 5 | 9 |
| 44 | FF | ● | ● | 2, 5 | 9 |
| 12 | 34 | With contactor control (observe Chapter 3.2.6) | | Must | Option |
| CC | 00 | - | ● | 1, 2 | 9 |
| CC | 11 | - | ● | 1, 2 | 9 |
| CC | 22 | - | ● | 1, 2 | 9 |
| CC | 33 | - | ● | 1, 2 | 9 |
| CC | 44 | - | ● | 1, 2 | 9 |
| CC | 55 | - | ● | 1, 2 | 9 |
| CC | 66 | - | ● | 1, 2 | 9 |
| CC | 77 | - | ● | 1, 2 | 9 |
| CC | 88 | ● | ● | 1, 2, 5 | 9 |
| CC | 99 | ● | ● | 1, 2, 5 | 9 |
| CC | AA | ● | ● | 1, 2, 5 | 9 |
| CC | BB | ● | ● | 1, 2, 5 | 9 |
| CC | CC | ● | ● | 1, 2, 5 | 9 |
| CC | DD | ● | ● | 1, 2, 5 | 9 |
| CC | EE | ● | ● | 1, 2, 5 | 9 |
| CC | FF | ● | ● | 1, 2, 5 | 9 |

1 OSSD2 cuts out with a delay of approximately 0.5 s.

2 Terminals 1A and 2A can be used for connecting external indicators of the protective field's state and starting units; refer to connection diagram 9.

Operating mode tables

6.8 Cycle control for insertion operations (cyclic infiltration of the protective field controls machine operations)

With restart interlock (observe Chapter 3.2.3)

Table 6

Hex switch



| | | Muting time limit ⁶ | Emergency-stop circuit ¹ | Cycle time monitoring ² | Cycle count ³ (work cycles) | External displays ⁵ for start & protective field status | Corresponding connection diagrams | |
|--------------|-------------------|--|-------------------------------------|------------------------------------|--|--|-----------------------------------|---------------|
| | | Obs. chapter 3.1.3 and 4.1! | Obs. chapter 3.2.2! | Obs. chapter 3.3.2! | Obs. chapter 3.3.2! | | | |
| 12 34 | | Without contactor control (observe Chapter 3.2.6) | | | | | Must | Option |
| 66 00 | ● (1 - 253s / 1h) | - | 30 s | 1 Cycle | ● | 2, 10 | 7, 9 | |
| 66 11 | ● (1 - 253s / 1h) | - | 30 s | 2 Cycle | ● | 2, 10 | 7, 9 | |
| 66 22 | ● (1 - 253s / 1h) | - | 30 s | 3 Cycle | ● | 2, 10 | 7, 9 | |
| 66 33 | ● (1 - 253s / 1h) | - | 30 s | 4 Cycle | ● | 2, 10 | 7, 9 | |
| 66 44 | ● (1 - 253s / 1h) | - | 120 s | 1 Cycle | ● | 2, 10 | 7, 9 | |
| 66 55 | ● (1 - 253s / 1h) | - | 120 s | 2 Cycle | ● | 2, 10 | 7, 9 | |
| 66 66 | ● (1 - 253s / 1h) | - | 120 s | 3 Cycle | ● | 2, 10 | 7, 9 | |
| 66 77 | ● (1 - 253s / 1h) | - | 120 s | 4 Cycle | ● | 2, 10 | 7, 9 | |
| 66 88 | ● (1 - 253s / 1h) | ● | 30 s | 1 Cycle | - | 2, 4, 10 | 7 | |
| 66 99 | ● (1 - 253s / 1h) | ● | 30 s | 2 Cycle | - | 2, 4, 10 | 7 | |
| 66 AA | ● (1 - 253s / 1h) | ● | 30 s | 3 Cycle | - | 2, 4, 10 | 7 | |
| 66 BB | ● (1 - 253s / 1h) | ● | 30 s | 4 Cycle | - | 2, 4, 10 | 7 | |
| 66 CC | ● (1 - 253s / 1h) | ● | 120 s | 1 Cycle | - | 2, 4, 10 | 7 | |
| 66 DD | ● (1 - 253s / 1h) | ● | 120 s | 2 Cycle | - | 2, 4, 10 | 7 | |
| 66 EE | ● (1 - 253s / 1h) | ● | 120 s | 3 Cycle | - | 2, 4, 10 | 7 | |
| 66 FF | ● (1 - 253s / 1h) | ● | 120 s | 4 Cycle | - | 2, 4, 10 | 7 | |
| 12 34 | | With contactor control (observe Chapter 3.2.6) | | | | | Must | Option |
| EE 00 | ● (1 - 253s / 1h) | - | 30 s | 1 Cycle | ● | 1, 2, 10 | 7, 9 | |
| EE 11 | ● (1 - 253s / 1h) | - | 30 s | 2 Cycle | ● | 1, 2, 10 | 7, 9 | |
| EE 22 | ● (1 - 253s / 1h) | - | 30 s | 3 Cycle | ● | 1, 2, 10 | 7, 9 | |
| EE 33 | ● (1 - 253s / 1h) | - | 30 s | 4 Cycle | ● | 1, 2, 10 | 7, 9 | |
| EE 44 | ● (1 - 253s / 1h) | - | 120 s | 1 Cycle | ● | 1, 2, 10 | 7, 9 | |
| EE 55 | ● (1 - 253s / 1h) | - | 120 s | 2 Cycle | ● | 1, 2, 10 | 7, 9 | |
| EE 66 | ● (1 - 253s / 1h) | - | 120 s | 3 Cycle | ● | 1, 2, 10 | 7, 9 | |
| EE 77 | ● (1 - 253s / 1h) | - | 120 s | 4 Cycle | ● | 1, 2, 10 | 7, 9 | |
| EE 88 | ● (1 - 253s / 1h) | ● | 30 s | 1 Cycle | - | 1, 2, 4, 10 | 7 | |
| EE 99 | ● (1 - 253s / 1h) | ● | 30 s | 2 Cycle | - | 1, 2, 4, 10 | 7 | |
| EE AA | ● (1 - 253s / 1h) | ● | 30 s | 3 Cycle | - | 1, 2, 4, 10 | 7 | |
| EE BB | ● (1 - 253s / 1h) | ● | 30 s | 4 Cycle | - | 1, 2, 4, 10 | 7 | |
| EE CC | ● (1 - 253s / 1h) | ● | 120 s | 1 Cycle | - | 1, 2, 4, 10 | 7 | |
| EE DD | ● (1 - 253s / 1h) | ● | 120 s | 2 Cycle | - | 1, 2, 4, 10 | 7 | |
| EE EE | ● (1 - 253s / 1h) | ● | 120 s | 3 Cycle | - | 1, 2, 4, 10 | 7 | |
| EE FF | ● (1 - 253s / 1h) | ● | 120 s | 4 Cycle | - | 1, 2, 4, 10 | 7 | |

1 A two-channel emergency-stop circuit with a normally closed function is monitored at 1A and 2A; 1B and 2B are available for connecting muting sensors.

2 If the protective field is not interrupted over this period, the outputs can only be released if the field is interrupted the correct number of times followed by actuation of the start button. The time between the individual interruptions and actuation of the start button must not exceed the monitoring time.

3 Number of times the protective field is interrupted and cleared prior to release of the outputs.

5 Terminals 1A and 2A can be used for connecting external indicators of the protective field's state and starting units; refer to connection diagram 9

6 The muting time limiter sets the muting time to an adjustable value between 1 s and 253 s, or to a value of 1 hour.

7.1 Selection of required connection diagrams

PLSG1

| Connection plan # | | Functions |
|-------------------|---------------|--|
| Must | Option | Must: Always connect / Option: Connect depending on the application |
| 1 | | Contactor control (EDM) |
| 2 | | Restart interlock (start button connection); the start button can also be used for override. |
| | 6 | 4 muting sensors / muting lamp (needed for applications with 4 muting sensors) |
| | 7 | 2 muting sensors / muting lamp (needed for applications with 2 muting sensors) |
| | 8 | Stoppage of muting time limitation Only necessary for preventing inadvertent deactivation, for example, in case of material accumulation. |

7.1 Selection of required connection diagrams

PLSG2 / PLSG3

From the determined **operating mode table**, read the **numbers of the connection diagrams** for the selected mode.

Excerpt of operating mode table 1 (Page 22).

Example:

| 00 FF | - | ● (0 - 195s) | ● | - | - | ● (only PLSG3) | 3, 12 | f, 8 | |
|---------------------------|--|--------------|---|---|---|----------------|-------------|---------|--------|
| 12 34 | With contactor control (observe Chapter 3.2.6) | | | | | | | Must | Option |
| 88 00 | ● (1 - 253s / 1h) | - | - | - | - | - | 1, 2, 12 | 6, 7, 8 | |
| 88 11 | ● (1 - 253s / 1h) | - | - | - | - | ● (only PLSG3) | 1, 2, 4, 12 | 7, 8 | |
| 88 22 | ● (1 - 253s / 1h) | - | - | ● | - | - | 1, 2, 5, 12 | 6, 7, 8 | |
| 88 33 | ● (1 - 253s / 1h) | - | - | - | - | ● (only PLSG3) | 1, 3, 12 | 7, 8 | |
| 88 44 | - | - | ● | - | - | - | 1, 2, 12 | 6, 7, 8 | |
| Hex switch setting: 88 55 | → 88 55 | - | - | ● | - | ● (only PLSG3) | 1, 2, 4, 12 | 7, 8 | |
| 88 66 | - | - | ● | ● | - | - | 1, 2, 5, 12 | 6, 7, 8 | |
| 88 77 | - | - | ● | - | - | ● (only PLSG3) | 1, 3, 12 | 7, 8 | |

Number of required connection diagrams

Example for operating mode 88 55:

| Connection plan # | | Functions |
|-------------------|---------------|--|
| Must | Option | Must: Always connect / Option: Connect depending on the application |
| 1 | | Contactor control (EDM) |
| 2 | | Restart interlock (start button connection); the start button can also be used for override. |
| 4 | | Emergency-stop switch |
| | 7 | 2 muting sensors / muting lamp (needed for applications with 2 muting sensors) |
| | 8 | Stoppage of muting time limitation Only necessary for preventing inadvertent deactivation, for example, in case of material accumulation. |

With the **option** involving a BLPG programming unit (light grid beam blanking, switchover between operating modes with selector switch): Connection diagram 12 or 13

7.2 Terminal designations

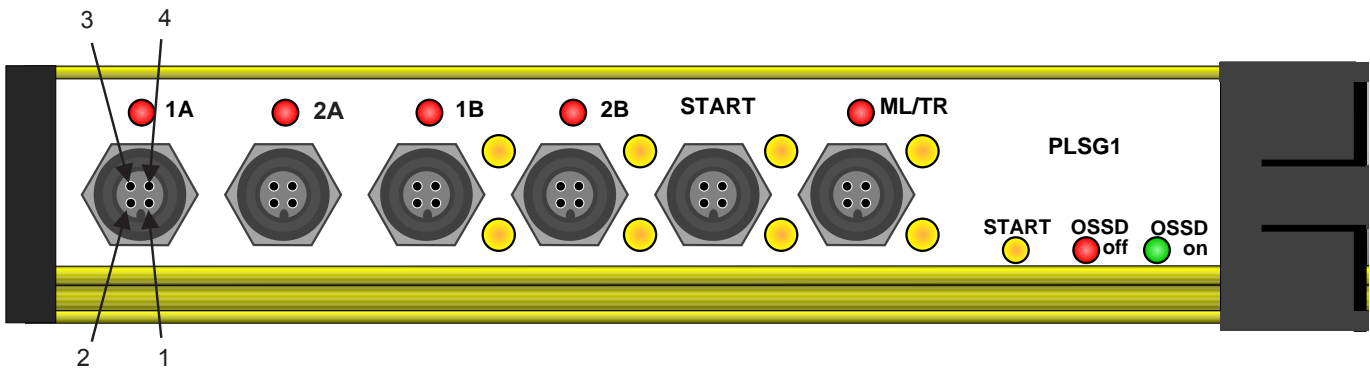
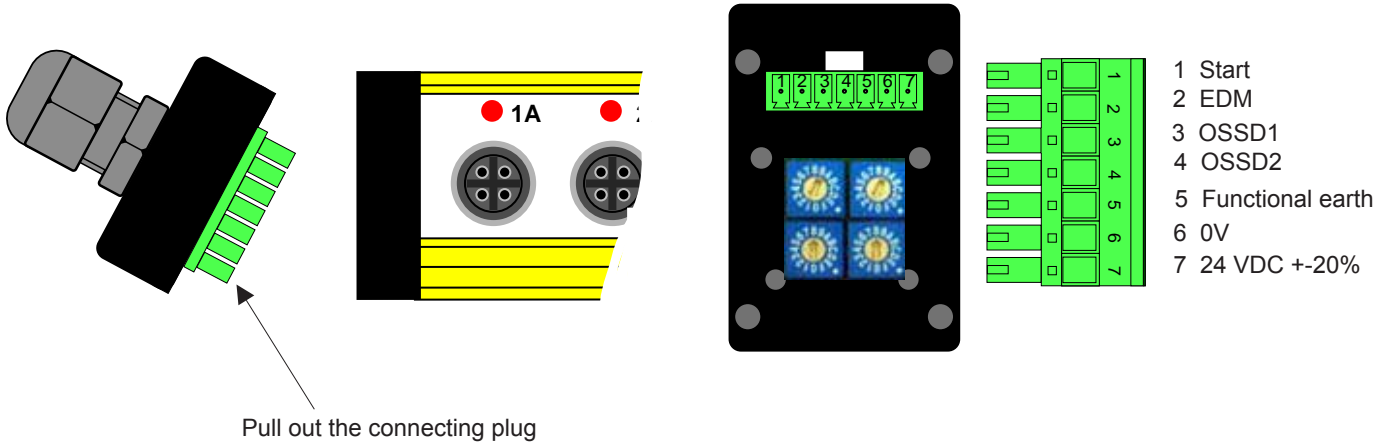

Pin assignment:

| 1A | 2A | 1B | 2B | Start | ML / TR |
|-----------|-----------|-----------|-----------|------------|---------|
| 1: MS1A + | 1: MS2A + | 1: MS1B + | 1: MS2B + | 1: Start + | 1: TR + |
| 2: MS1A + | 2: MS2A + | 2: MS1B + | 2: MS2B + | - | 2: ML + |
| 3: MS1A - | 3: MS2A - | 3: MS1B - | 3: MS2B - | - | 3: ML - |
| 4: MS1A E | 4: MS2A E | 4: MS1B E | 4: MS2B E | 4: Start E | 4: TR E |

IMPORTANT:

Safe operation is ensured only if the PLSG... has been connected according to the wiring diagrams and all relevant installation instructions have been observed. Electrical connections must only be established with the system in the de-energized state.

7.2.1 Control of external contactors and valves (EDM)

Connection diagram 1

| | |
|-------|--------------------|
| PLSG1 | Always |
| PLSG2 | acc. to oper. mode |
| PLSG3 | acc. to oper. mode |

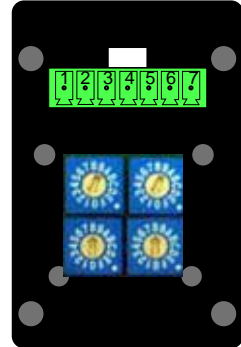
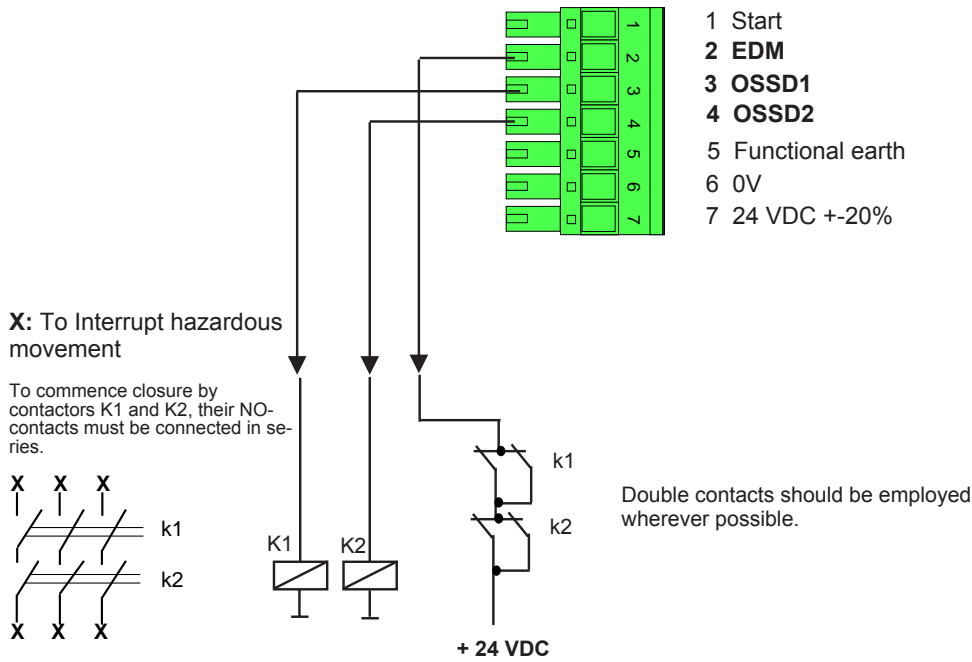

7.2.2 a) Restart interlock (connection of a start button for resetting restart interlock)
b) Override after unscheduled stop during muting

Connection diagram 2

| | |
|-------|--------------------|
| PLSG1 | Always |
| PLSG2 | acc. to oper. mode |
| PLSG3 | and application |

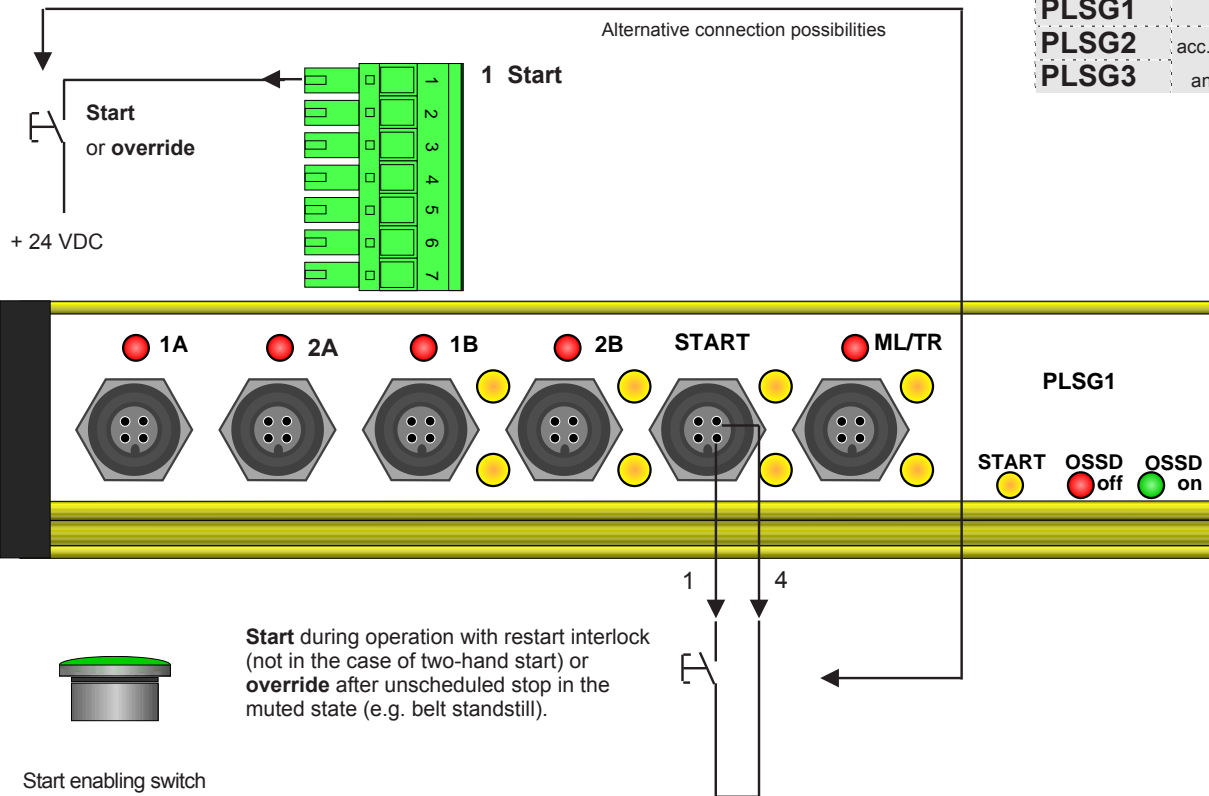

7.2.3 Two-hand start in the muting mode with restart interlock

Connection diagram 3

Only 2 muting sensors can still be connected to 1B and 2B.

PLSG3 In the case of muting modes 00xx and 88xx if the function has been selected.

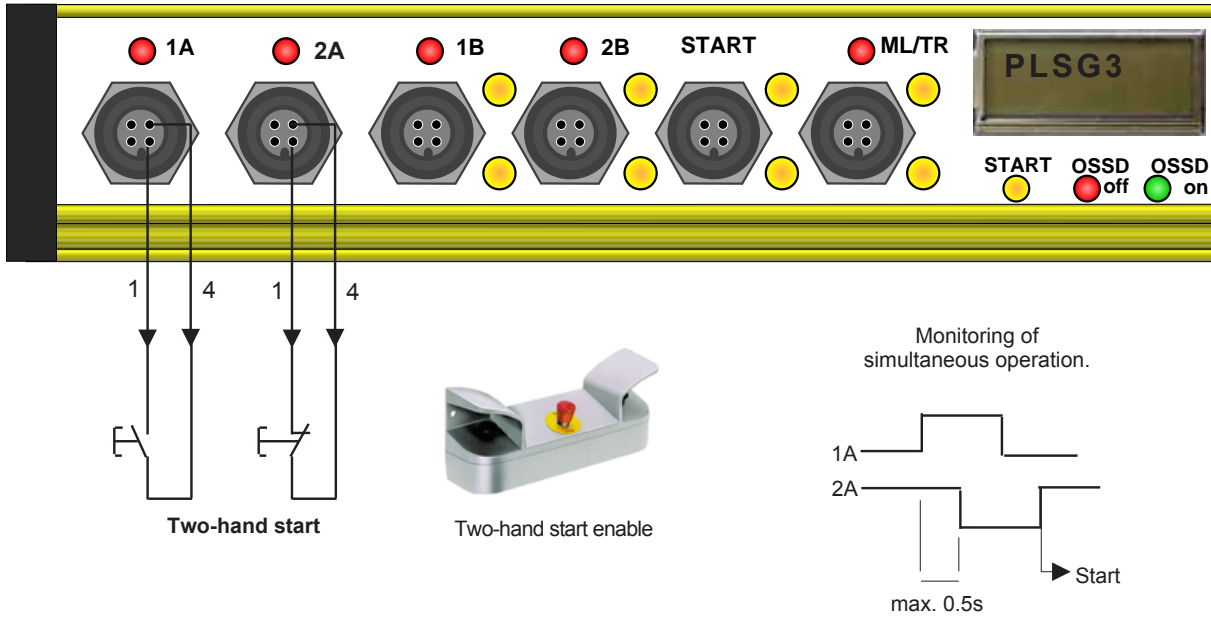

7.2.4 Emergency-stop circuit in muting modes

Connection diagram 4

Only 2 muting sensors can still be connected to 1B and 2B.

PLSG3 In the case of all muting modes if the function has been selected.

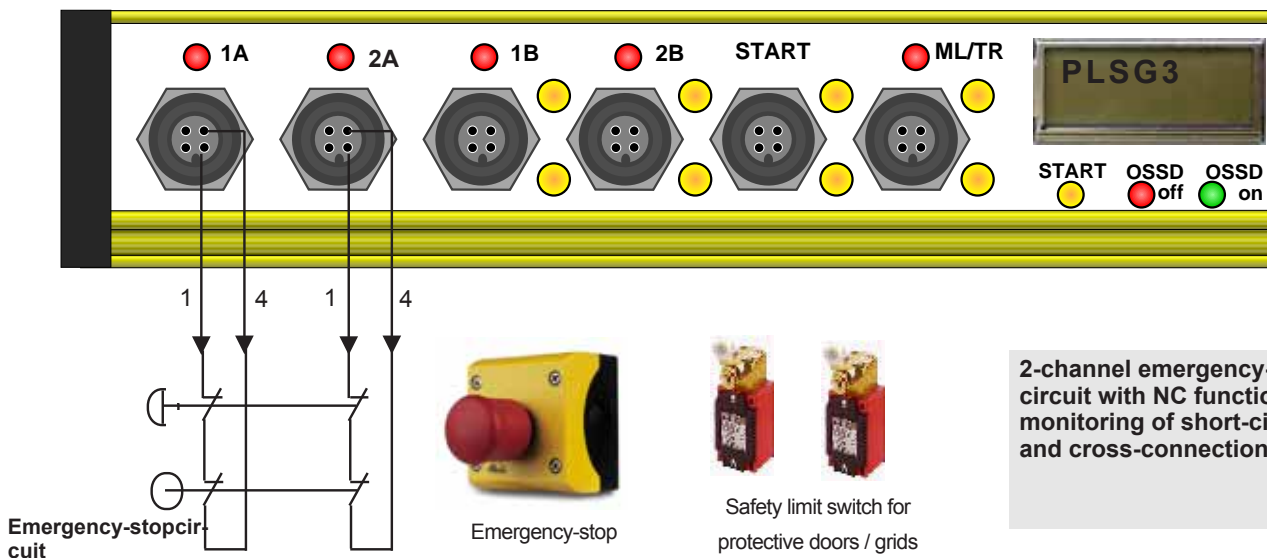

7.2.5 Two-stage deactivation of outputs (OSSD 2 turn-off delay)

(e.g. for robot safeguarding). For all applications in which hazardous movement must be brought to a controlled stop and the control system is not fail-safe. If the control system fails, the OSSD2 shuts down the drive after a delay of 0.5 s.

Connection diagram 5

| | |
|--------------|-------------------|
| PLSG2 | acc.to oper. mode |
| PLSG3 | acc.to oper. mode |

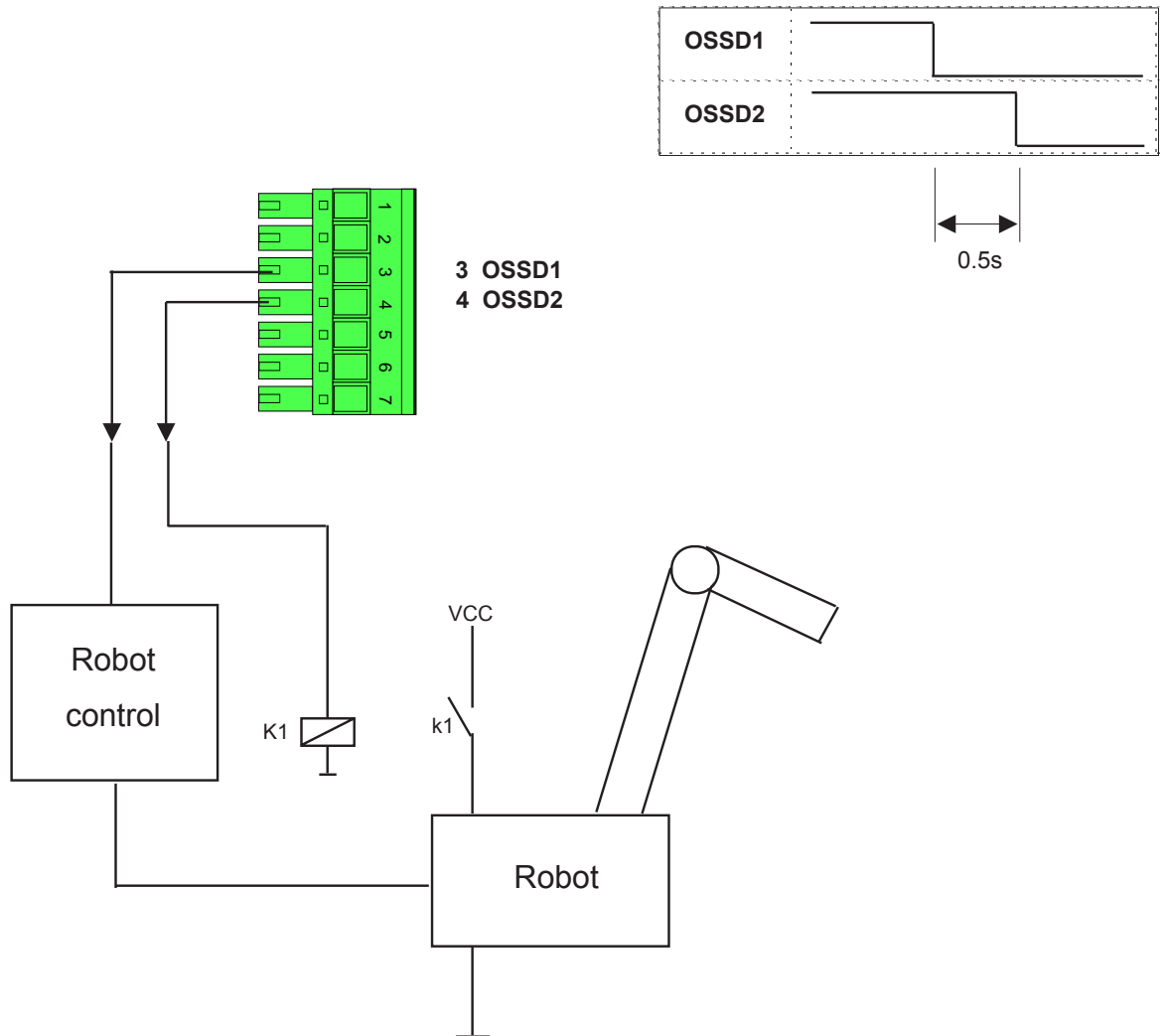

IMPORTANT :

Opening of K1 during deactivation of OSSD 2 must be monitored by the machine control or the PLSG according to wiring diagram 1 (with selection of contactor control via the hex switches).

The maximum response time from interruption of the light curtain to end of the hazardous movement is calculated as follows: Response time ULVT/BLVT + response time PLSG...K (3.5 ms) + **500ms** + switching time K1 + uncontrolled braking time. **OSSD1 and OSSD2:** Fail-safe PNP outputs, max. 0.5 A, monitored for short-circuit and cross-connections.

7.2.6 Muting function with 4 muting sensors / external muting lamp

Connection diagram 6

| | |
|-------|---------------------|
| PLSG1 | acc. to application |
| PLSG2 | acc. to application |
| PLSG3 | acc. to application |



IMPORTANT :

Bypass (muting) remains active as long as contacts / sensors
A and 2 A or
A and 1 B or
1 B and 2 B
are conductive, or until the muting time limit has expired.

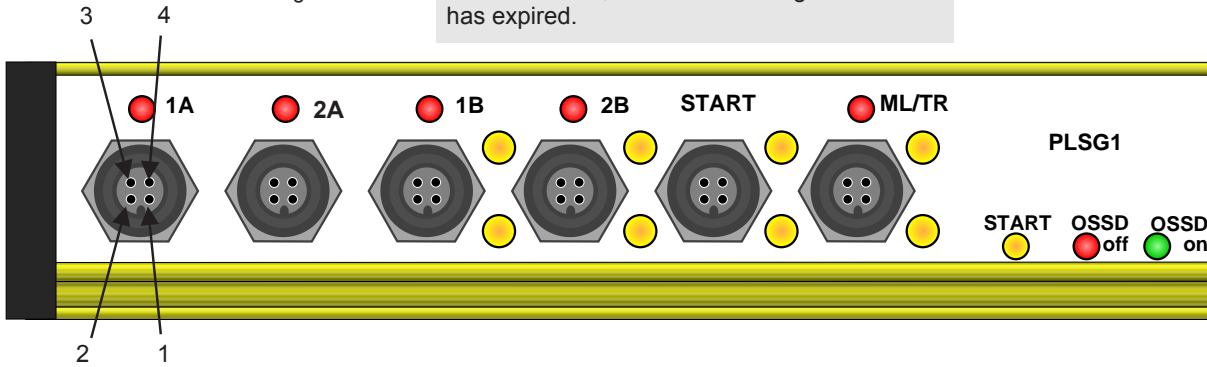

Muting-sensors with relay outputs

Contact is conductive in the muted state (dark switching)

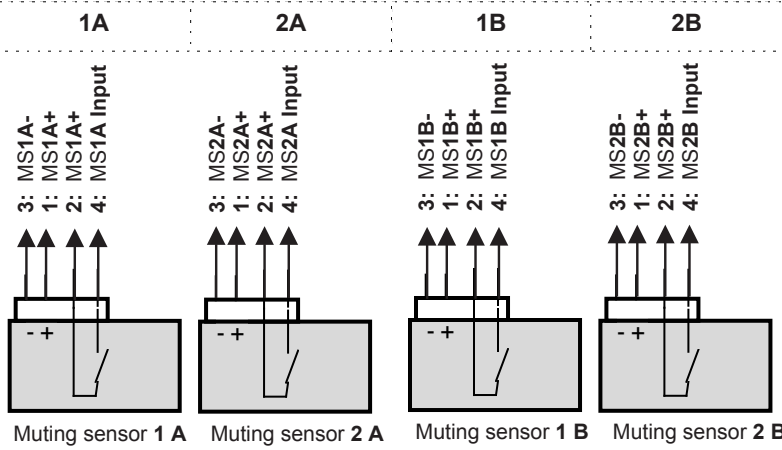

External muting lamp 24V, max. 0.5A, at least 50 mA, can be connected optionally

Muting-sensors with transistor outputs, conductive in the muted state (dark switching)

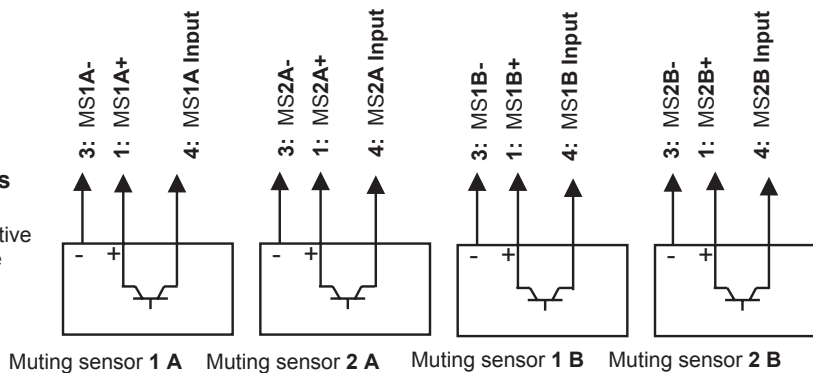

LEDs 1A, 2A, 1B and 2B come on when the related muting sensor applies + 24V to pin 4 of the corresponding socket (muting request).

7.2.7 Mutingfunktion mit 2 Muting sensors / externe Muting lamp

Connection diagram 7

| | |
|-------|---------------------|
| PLSG1 | acc. to application |
| PLSG2 | acc. to application |
| PLSG3 | acc. to application |

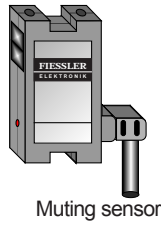

IMPORTANT :

Bypass (muting) remains active as long as contacts / sensors
 1 A and 2 A or
 2 A and 1 B or
 1 B and 2 B are conductive, or until the muting time limit has expired.

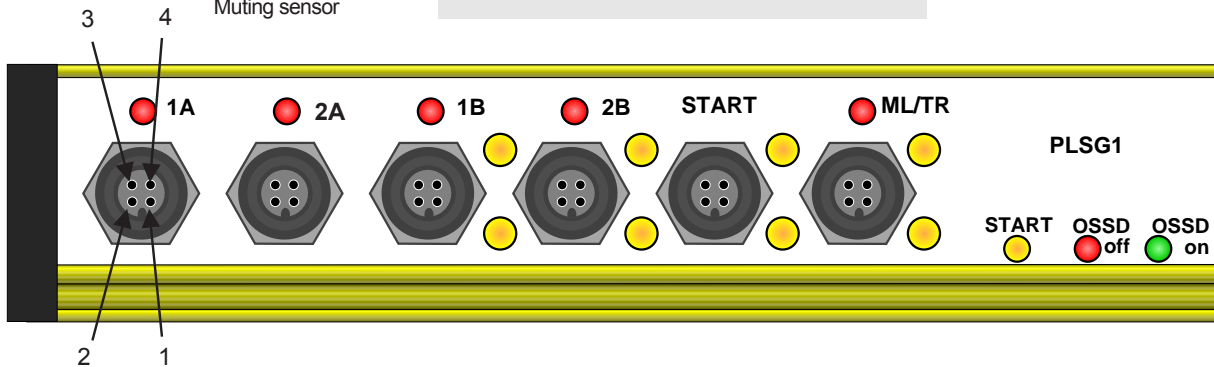

Mutingsensors with relay outputs

Contact is conductive in the muted state (dark switching)

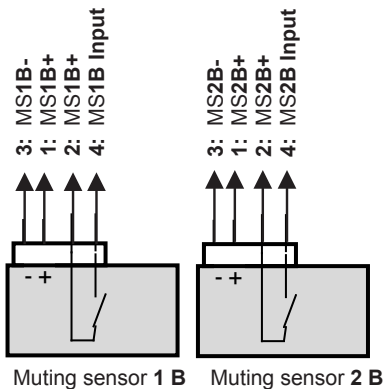

External muting lamp 24V, max. 0.5A, at least 50 mA, can be connected optionally

Muting sensors with transistor outputs

conductive in the muted state (dark switching)

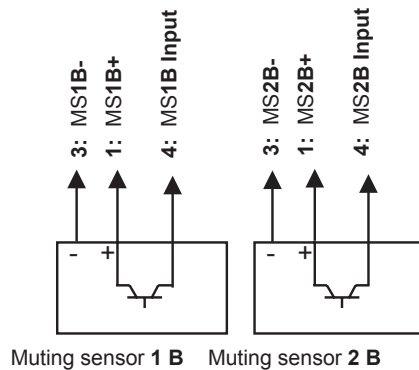

LED 1B and 2B come on when the related muting sensor applies + 24V to pin 4 of the corresponding socket (muting request).

7.2.8 Stoppage of muting time limiting, for example, on belt standstill

Connection diagram 8

| | |
|-------|---------------------|
| PLSG1 | acc. to application |
| PLSG2 | acc. to application |
| PLSG3 | acc. to application |

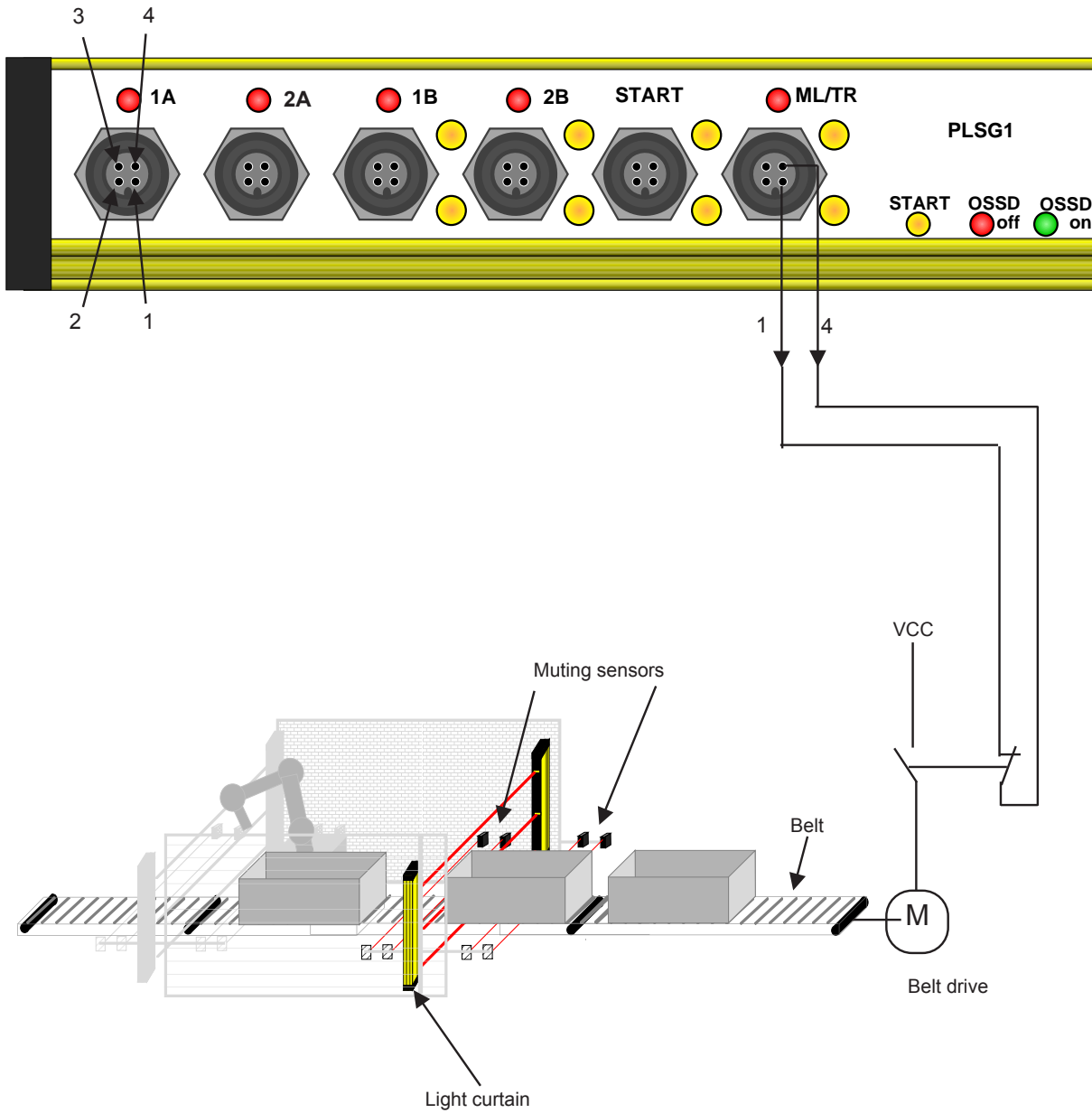

As soon as the conveyor belt is stopped, so is the muting time limiter.

This prevents unwanted stoppage provoked by muting time overflow in the case of material accumulation.

7.2.9 External displays for restart interlock and protective field status

Connection diagram 9

PLSG3

acc. to oper. mode
tables 3, 5, 6

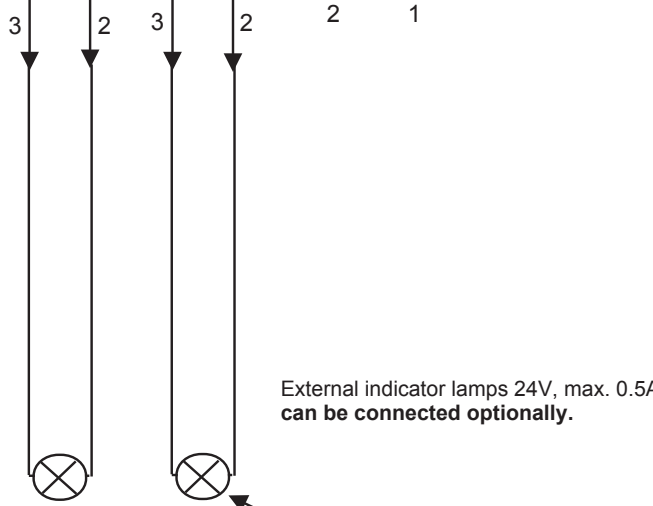
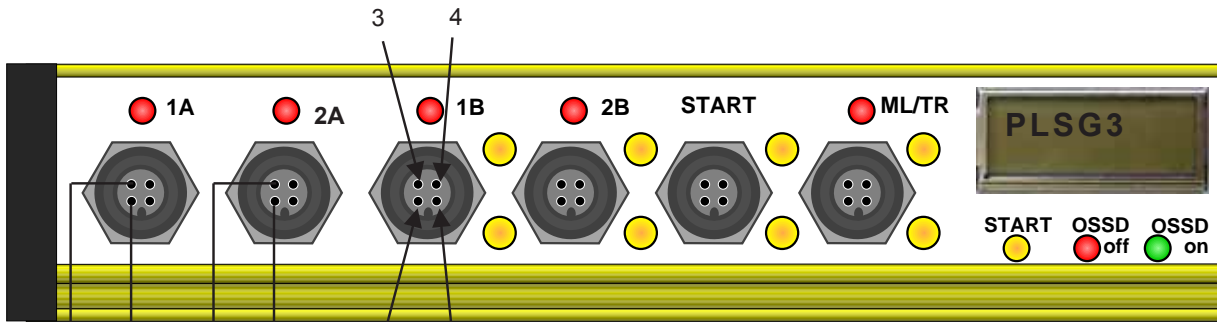

External indicator lamps 24V, max. 0.5A,
can be connected optionally.

Protective field status indicator
comes on when the protective field is clear.

Restart interlock indicator comes on when restart is enabled by actuating the start button.

7.2.10 Cyclic mode (automatic start of work cycles during insertion operations)

Connection diagram 10

PLSG3

Only in the case of operating modes 66xx and EExx, table 6

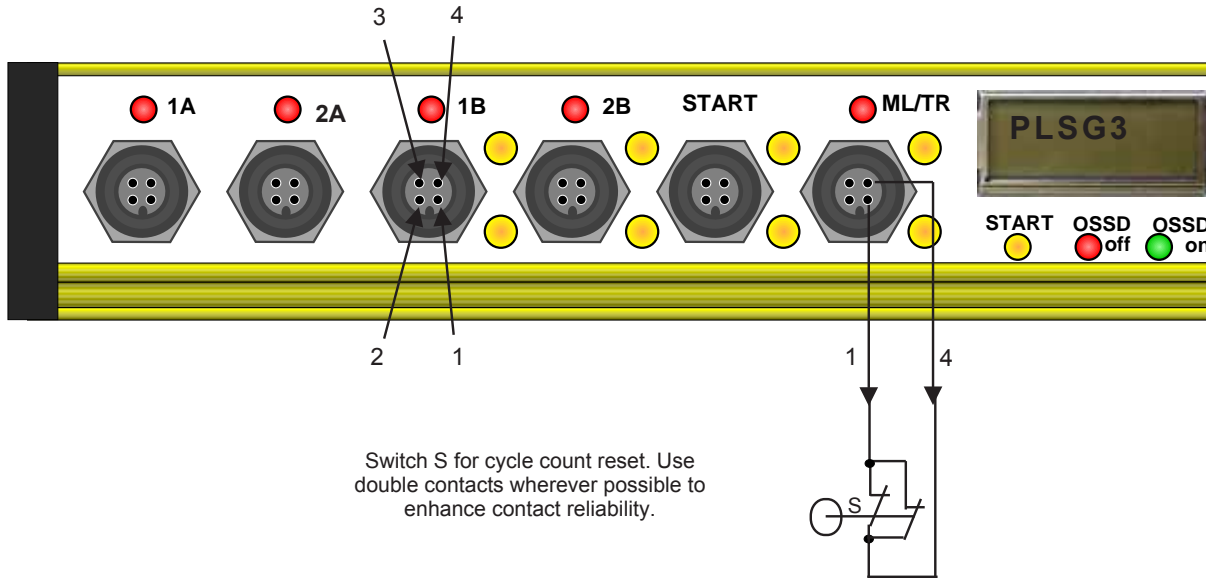

Example of 2-cycle control on a machine similar to a press brake: After the safety device is started, the protective field must be infiltrated as many times as necessary for triggering a work movement, i.e. 2 operations (cycles) in this case (refer to 1). After subsequent actuation of the start button (2) with the protective field clear, the OSSDs close and the machine movement is started (3).

At the end of the work movement, the cycle reset switch S opens and the OSSDs open too (4). As long as S remains open (at least 30 ms), any intervention of the protective field (5) does not count as an operation for releasing the work movement. The 2 interventions (6) after the closing of S make the OSSDs close again, therefore starting a new work movement (7).

If the protective field is interrupted during hazardous movement (8), the OSSDs open and the work movement is stopped. A new work movement (12) is produced only after 2 more operational interruptions (9) and actuation of the start button (10).

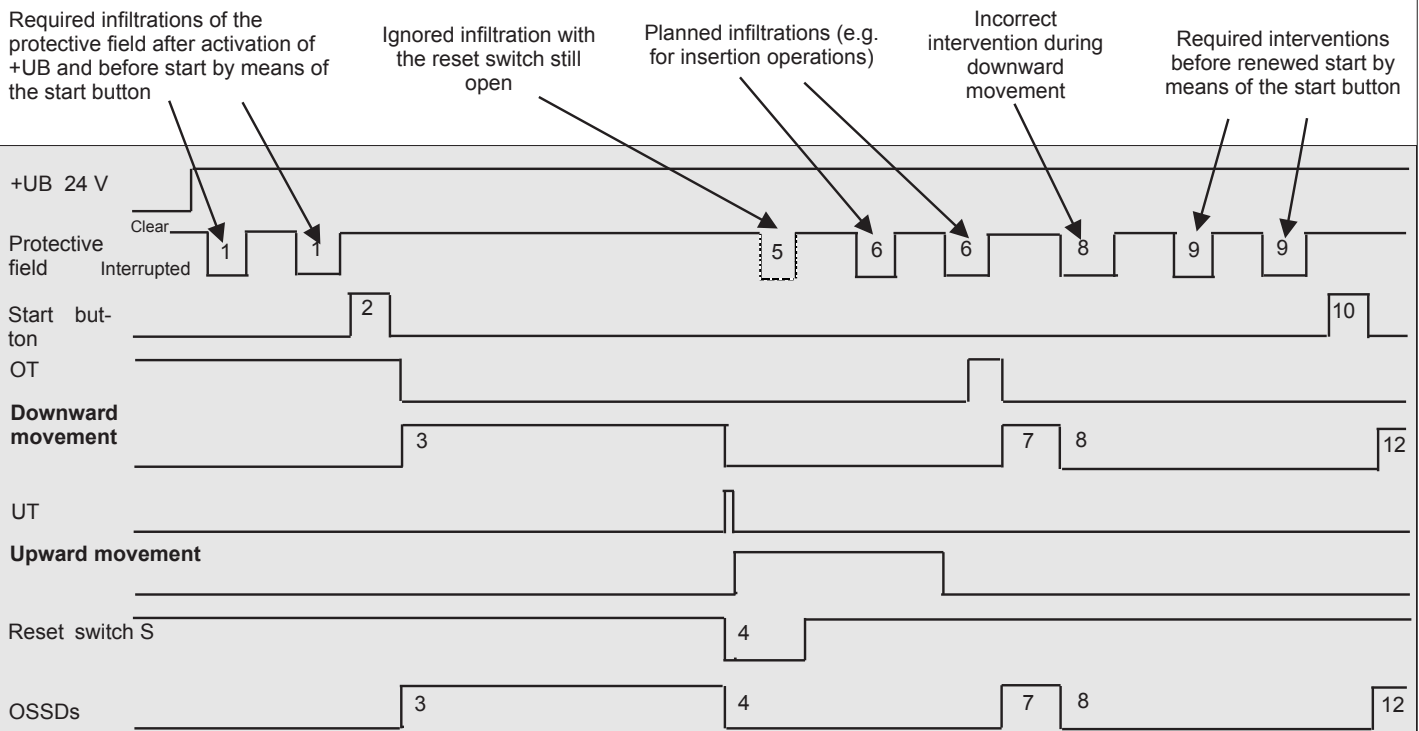

7.2.11 Restart interlock with two-hand start and emergency-stop circuit monitoring / without muting functions

Connection diagram 11

PLSG3 Only in the case of operating modes 7700 and FF00, table 4

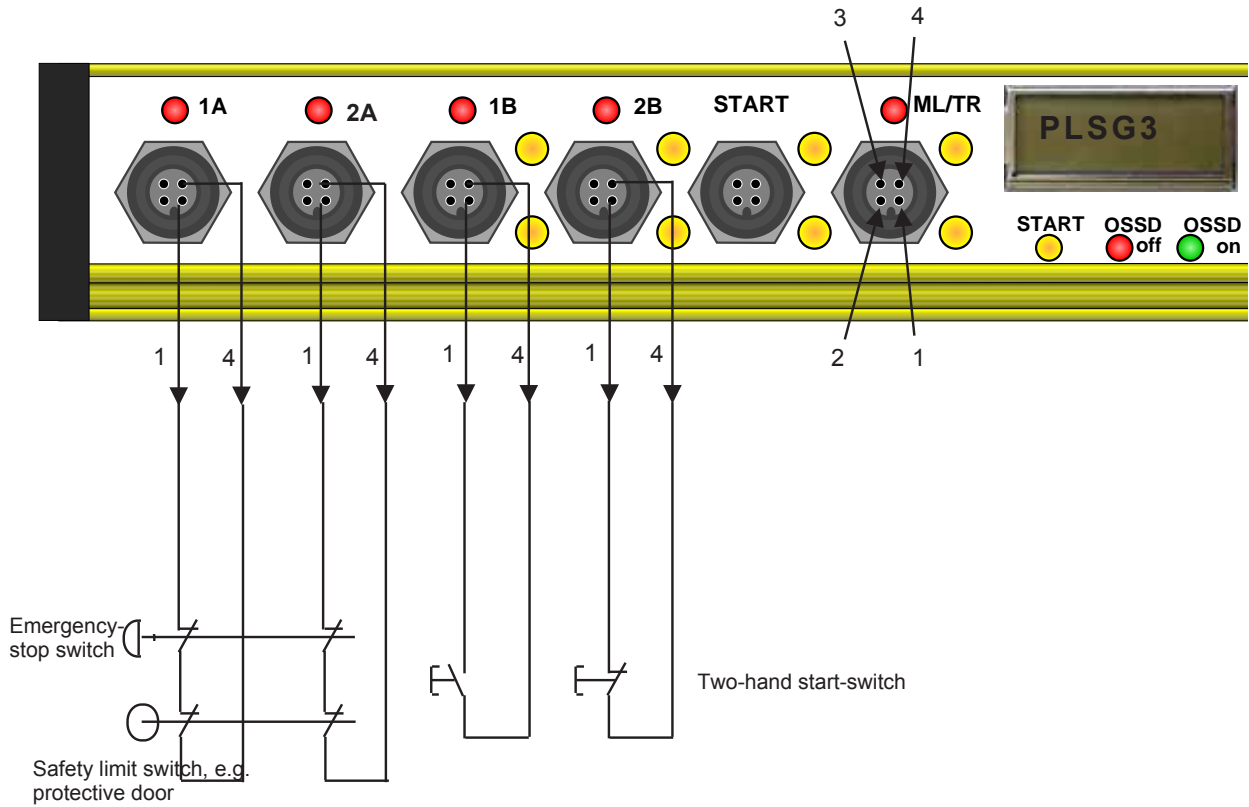

2-channel emergency-stop circuit with NC function;
monitoring of short-circuits and cross-connections

Two-hand start
with monitoring of simultaneous actuation

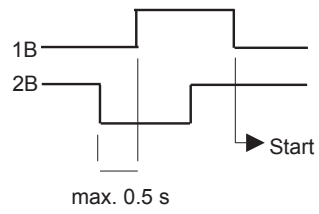

7.2.12 Optional with BLPG: Beam blanking functions for the BLVT light grid

Connection diagram 12

(with external key switch)

| | |
|--------------|--------|
| PLSG2 + BLPG | Always |
| PLSG3 + BLPG | Always |



Key switch

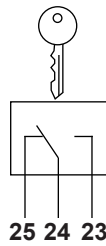

25 24 23

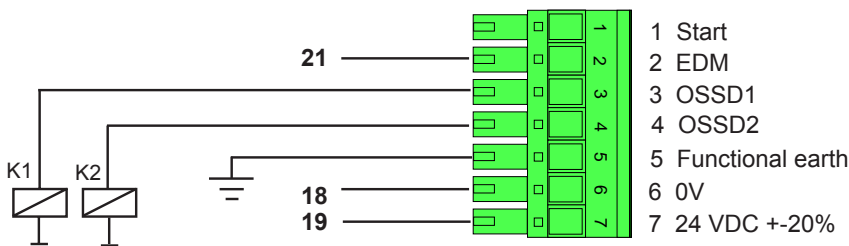
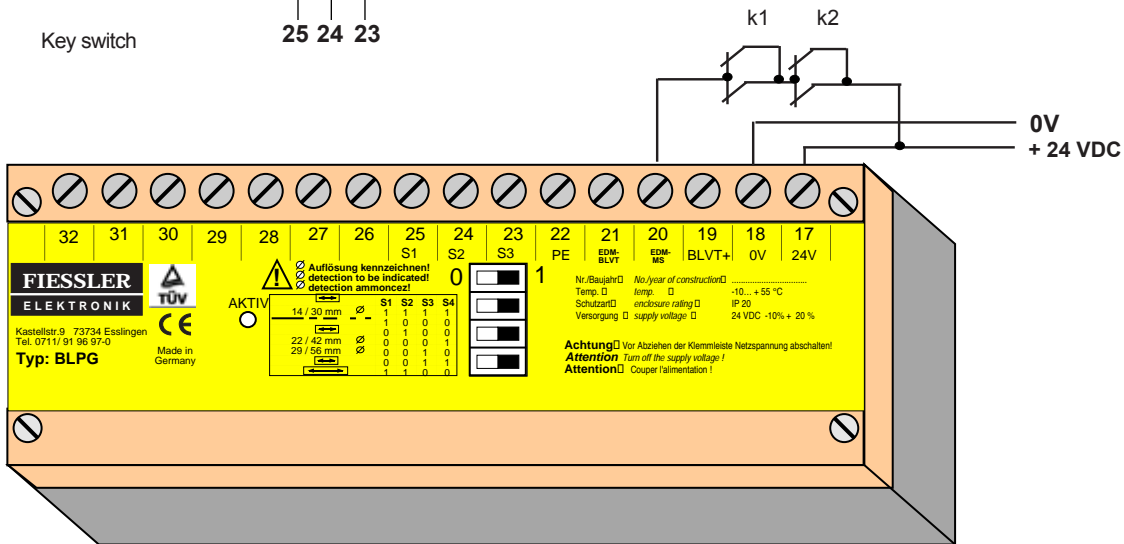

- 1 Start
- 2 EDM
- 3 OSSD1
- 4 OSSD2
- 5 Functional earth
- 6 0V
- 7 24 VDC +-20%

PLSG

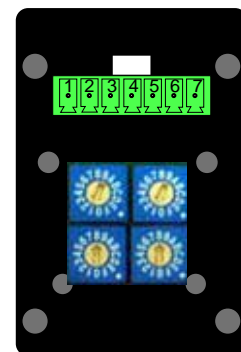

(Description on Page 12)

Teach-in of beam blanking functions for the BLVT light grid

7.2.13 Optional with BPLG: Operating-mode changeover with an external selector switch

Connection diagram 13

PLSG3 + BPLG acc. to application

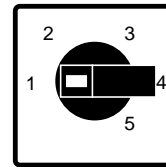
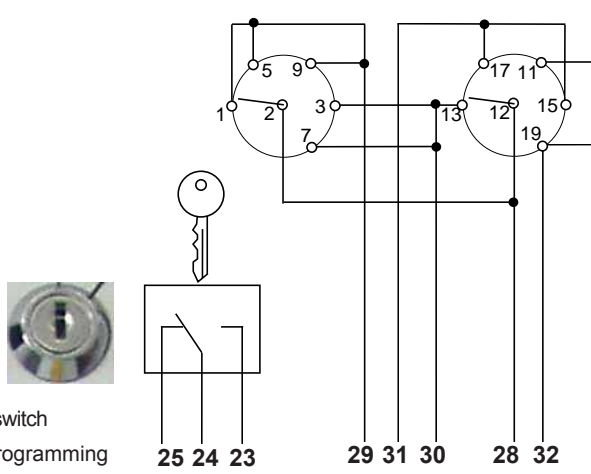

Selector switch for changing between max. 5 stored blanking types and / or operating modes of the PLSG3
e.g. KRAUS & NAIMER CA4-1 A252-600 FS2
2-pole (2 levels), 5 switching stages.

Terminal bridges must remain in the configuration as on delivery.

| selector switch | Contacts connected |
|-----------------|--------------------|
| 1 | 28 + 29 + 30 |
| 2 | 28 + 29 + 31 |
| 3 | 28 + 29 + 32 |
| 4 | 28 + 30 + 31 |
| 5 | 28 + 30 + 32 |

Key switch for programming

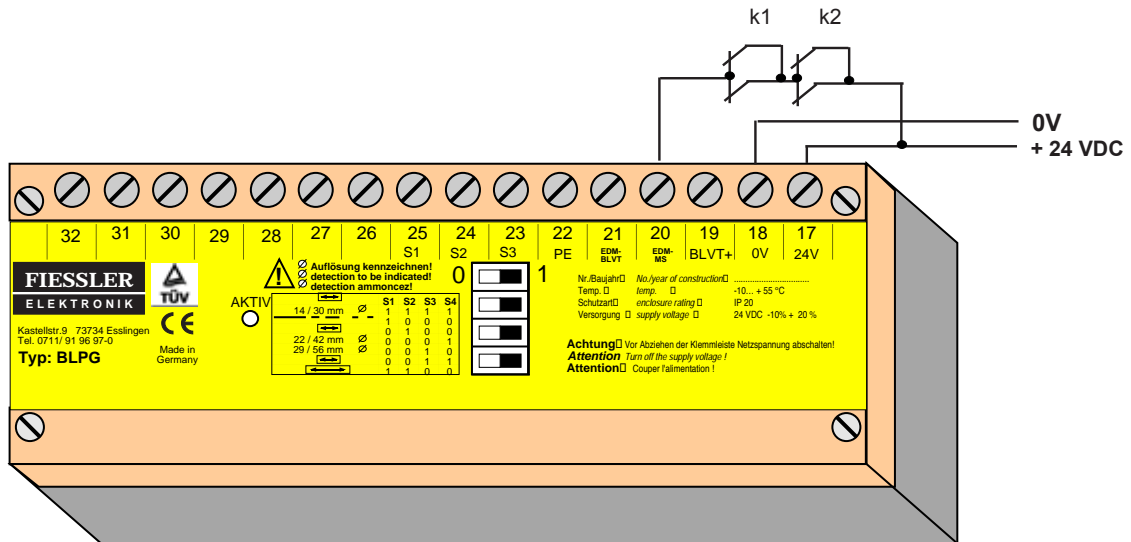

PLSG3

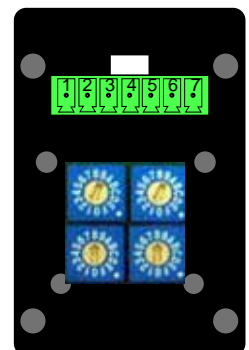

Possibilities (described on Pages 13/14/15)

- a) Storage and recall of up to 5 operating modes in the PLSG3
- b) Storage and recall of up to 5 beam blanking types in the BLVT light grid
- c) Storage and recall of up to 5 operating modes in the PLSG3; storage and recall of up to 5 beam blanking types in the BLVT light grid

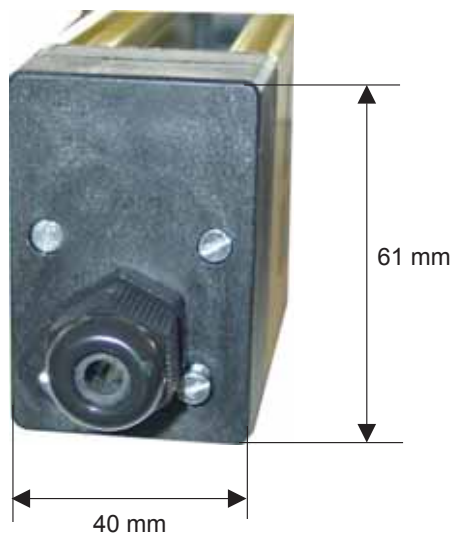
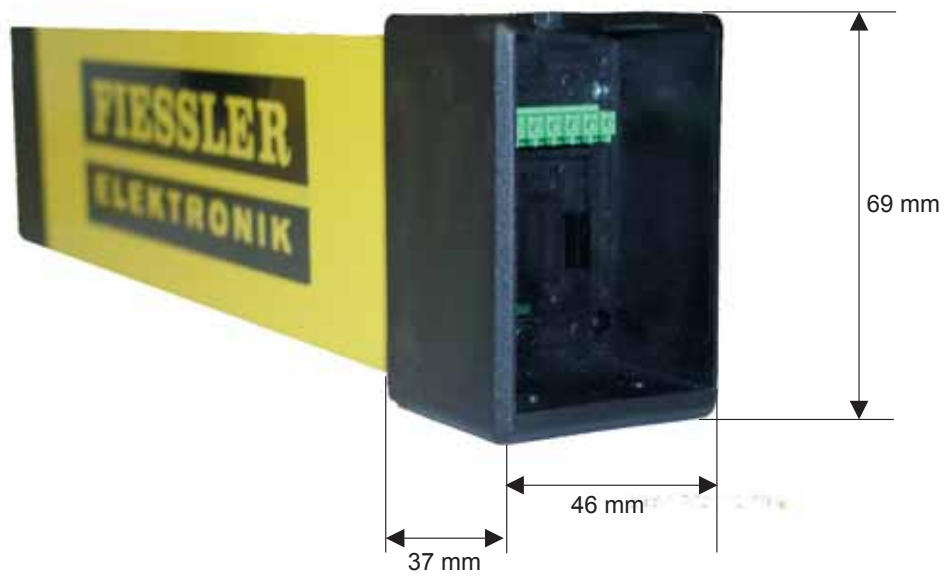
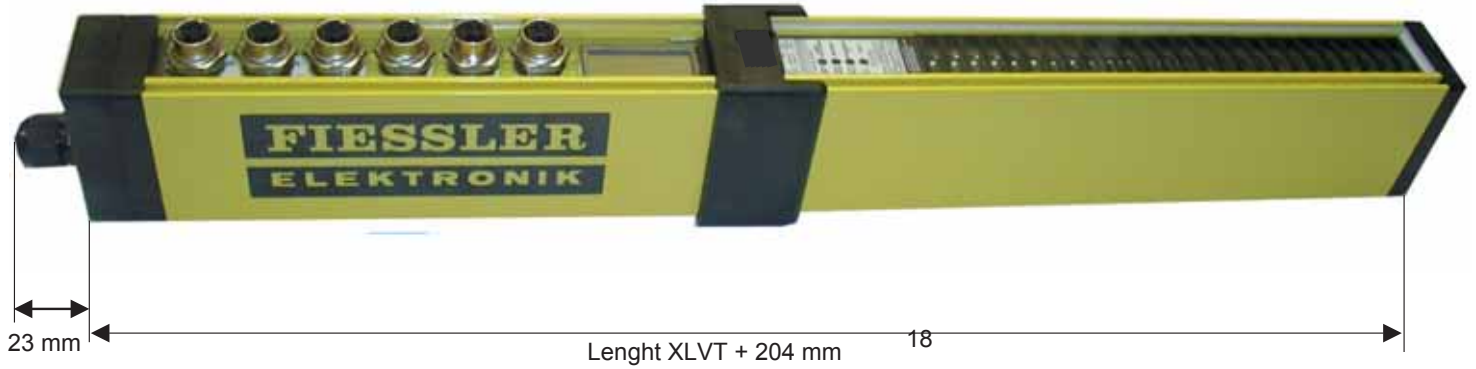

The PLSG is fit directly on the plug side of the light grid of the ULVT / BLVT series.
For this purpose, remove the connection cover on the light grid.

When fitting the PLSG, ensure that the spring catch on the front panel engages.

To **remove** the PLSG, loosen the screws, slide a **coin** underneath the spring catch and pry apart the two housing sections.



1. Remove the connection cover

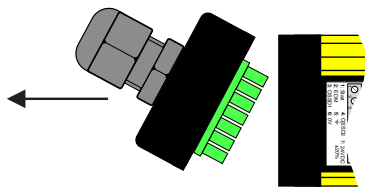

2. Check the dip switch on the light grid and fit on the PLSG

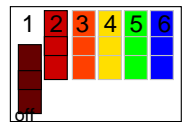
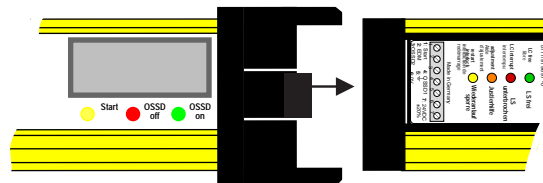

3. After wiring is complete, fit the connection cover on the PLSG and screw it in place.

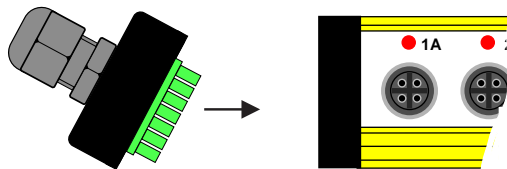

4. Slide the slot blocks under the grooves of the PLSG lid, insert the corresponding screws and tighten them.

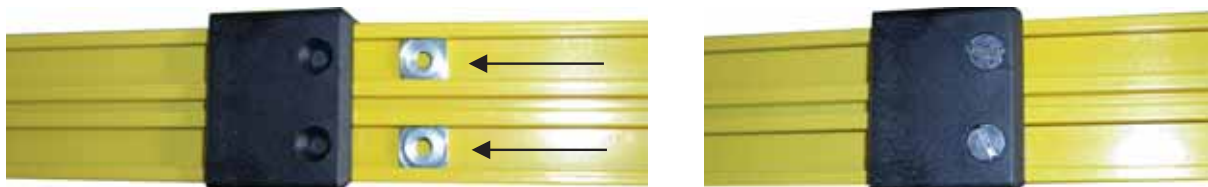

IMPORTANT:

The PLSG must rest accurately on the ULVT/BLVT without any misalignment.

Using the dip switches set the ULVT / BLVT to

- without restart interlock
- without contactor control
- synchronized outputs

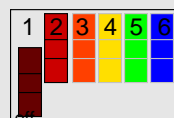

before fitting on the PLSG.

| Technical data | |
|---|--|
| Safety Category | 4 (EN ISO 13849-1:2008) and EN 61496 or IEC 61496 |
| Performance Level | PL e (EN ISO 13849-1:2008) |
| Safety Integrity Level | SIL3 (EN 62061:2005) |
| Protection type | IP 65 |
| Protection class | III |
| Ambient operating temperature | -10 to 55 °C |
| Storage temperature | -25 to 70 °C |
| Supply voltage | 24 V DC, ±20%, (SELV). The external supply voltage must be able to bridge brief power failures for up to 2 ms according to EN 60 204. |
| Current consumption | Max. 250 mA (without load). |
| Outputs | OSSD1 and OSSD2: Fail-safe PNP outputs, max. 0.5 A, with short-circuit and cross-connection monitoring. |
| Electrical connection | Integrated plug connector with PG9 for strain relief, or standard commercial plug connector. |
| Connection cable | 5 to 7-pole (depending on the operating mode); max. 1.5 mm ² |
| Max. response time | After interruption of the light grid's protective field : 3.5 ms + XLVT response After interruption of the emergency-stop circuit: 30 ms if both circuits open, or 63 ms if only one circuit opens due to a defect If OSSD 2 turn off delay is active: 0.5 s. |
| Muting response time | Minimum activation / deactivation time for the muting sensors: 30 ms + muting sensors switching time |
| Muting time limit | PLSG1: 1 h* / PLSG2 and PLSG3: 1 to 253 s or 1 h** (on delivery: 30s) |
| Delayed end of muting | PLSG1: not possible / PLSG2 and PLSG3: 0 to 30 s, or 0 to 195 s (on delivery: 0s) |
| Override state | Max. 35 s |
| Inputs | 0V to 24 V DC +-20% / 10 mA, (at least 15 V to allow detection of high levels). |
| External muting lamp | 24V max. 0.5 A, min. 50 mA |
| Minimum time for cycle counter reset | 30 ms |

* **Muting time limit firmly set:** 1 hour

** **Max. muting time limit adjustment:** 1 to 253 s or 1 hour

If the function "immediate end of muting on clearing of the protective field" has been selected, there is no muting time limit.

LED 1A, 2A, 1B and 2B come on when the related muting sensor applies + 24V to pin 4 of the corresponding socket (muting request see connection diagram 6 / 7)

LED ML /TR comes on when + 24V are applied to input pin 4.

In muting mode: **Stoppage of muting time limitation**(see connection diagram 8)

In the cycle control mode:

Cycle reset when TR = 0V(see connection diagram 10)

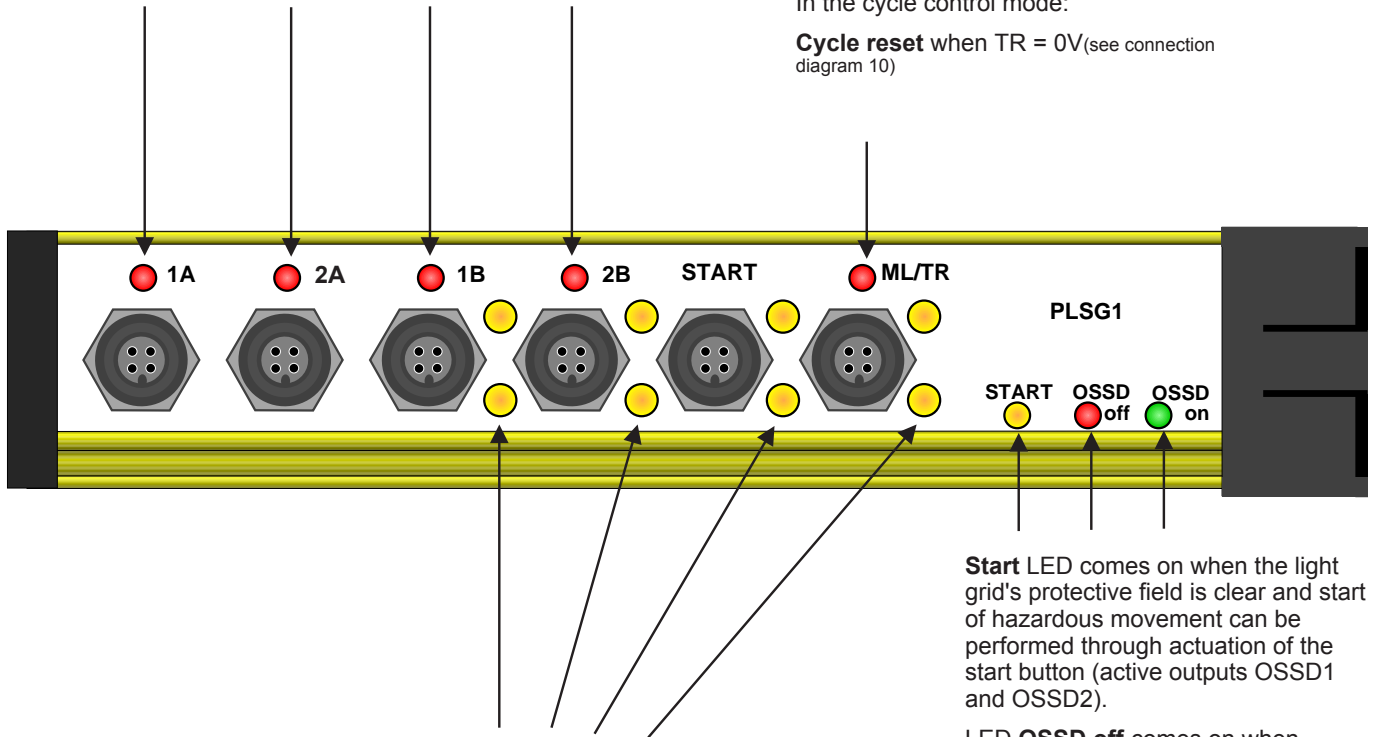



8 yellow LEDs come on when the light grid is bypassed (muting)

Start LED comes on when the light grid's protective field is clear and start of hazardous movement can be performed through actuation of the start button (active outputs OSSD1 and OSSD2).

LED **OSSD off** comes on when outputs OSSD1 and OSSD2 are inactive.

LED **OSSD on** comes on when outputs OSSD1 and OSSD2 are active.

| Fault | PLSG1 | PLSG2 | PLSG3 | Display on PLSG3 PLSG2 | Possible causes | Remedies |
|---|-------|-------|-------|---|--|--|
| OSSDs are disabled | - | X | X | invalid op. mode | Hex switches are incorrectly adjusted or their adjustment has been modified during operation. | Read the operating instructions and adjust the hex switches correctly. |
| OSSDs are disabled | X | X | X | OSSD error | Short-circuit between the lines connected to the OSSDs; short-circuit of one of these lines after + or -, or internal fault. | Check the OSSD connection lines. If these lines are OK, PLSGK must be returned to Fiesler Elektronik for testing. |
| OSSDs are disabled (+ 1 PLSG at the yellow flashing LED START after power reset | X | X | X | contact. check | Monitoring contacts of downstream switching devices do not close. Interruption of the monitoring channel (EDM). Downstream switching elements are not released. | Check monitoring channel. Change contacts. Check switching devices (downstream contactors). |
| OSSDs are switched briefly on and off | X | X | X | check contact. | Monitoring contacts of downstream switching units do not open. Short-circuit of monitoring channel after +24V. Interruption in triggering of downstream switching devices. | Check monitoring channel. Check control of downstream switching devices. |
| Muting is disabled and at least one pair A1-A2 or A2-B1 or B1-B2 of red LEDs at the muting inputs light up as soon as material interrupts the protective field. | X | X | X | No fault message | Muting sensors are incorrectly placed. Installation order of the muting sensors is wrong. A muting sensor output is permanently in the non-muting state. Interruption of muting cables. | The muting sensors must be connected in a way that one of the muting sensor pairs A1-A2 or A2-B1 or B1-B2 always detects the material when it interrupts the protective field. Test the function of each muting sensor whose corresponding red LED at the PLSGK does not light up. Check the cabling of the muting sensors. |
| Muting is disabled and one red LED of the muting inputs lights up. | X | X | X | at least after voltage reset override possible | Incorrectly adjusted or defective muting sensor. Short-circuit in muting sensor cable. | Readjust muting sensors. Check muting sensors. Check muting sensor cables. |
| Muting disabled | X | X | X | muting lamps defect | Both muting lamps are defective (only version with 2 muting lamps). Muting lamp is defective. | Check the muting lamps. Check the muting lamps' connections and wiring. |
| Muting disabled | X | X | X | muting time stop error | The muting time limitation stoppage input TR is connected to +24V before the muting sensors assume the muting state. | Check the cabling for short circuit. Check whether the control unit is OK. |
| Muting is sporadically disabled and conveyance speed fluctuates. | - | X | X | No fault message | The muting time limit is too short. | Set the muting time limit corresponding to the slowest conveyance speed. |
| Muting is sporadically disabled and length of conveyed items varies. | X | X | X | No fault message | The muting sensors are mounted too far apart. | The muting sensors must be mounted in a way that each muting sensor pair detects even the shortest conveyed items.  Important: The sensors must be mounted in a way that the protective field cannot be passed through inadvertent triggering of the muted state. |

| Fault | PLSG1 | PLSG2 | PLSG3 | Display on PLSG3 PLSG2 | Possible causes | Remedies |
|--|-------|-------|-------|------------------------|--|--|
| Muting is sporadically disabled and the interval between conveyed items varies. | X | X | X | No fault message | <p>If the function "immediate end of muting when protective field is cleared again" is selected:</p> <p>Before the first conveyed item leaves the protective field, subsequent items are detected by a muting sensor.</p> <p>If this function is not selected:</p> <p>At the smallest interval between conveyed items, several such items consecutively pass the muting sensors, so that the muting time limit expires before recurrence of a state in which none of the muting sensors detects a conveyed item.</p> | <p>Install the muting sensors closer to the protective field.</p> <p>Increase the interval between the conveyed material items.</p> <p>Deselect the function "end of muting when protective field is cleared again".</p> <p>Extend the muting time limit.</p> <p></p> <p><u>Important: The sensors must be mounted in a way that the protective field cannot be passed through inadvertent triggering of the muted state.</u></p> |
| One muting lamp flashes in the muted state. | X | X | X | mut.lamp ERROR | <p>On the version with 1 muting lamp: No fault. On the version with 2 muting lamps:</p> <p>The muting lamp which is inactive in the muting state has an interruption. The second muting lamp is not connected or its connection is interrupted.</p> | <p>Only on the version with 2 muting lamps:</p> <p>A repair is only necessary if availability needs to be enhanced, or if the remaining muting lamp is not visible from operator's position.</p> |
| Muting lamps go off although a pair of sensors needed for the muted state still detects conveyed material. | - | X | X | muting end | <p>If the function "immediate end of muting when protective field is cleared again" is selected: The conveyed material has passed the protective field – no fault.</p> <p>If this function is not selected: The muting sensors detect the presence of conveyed material for a longer time than the programmed muting monitoring time.</p> | <p>No fault. Extend the muting time limit. Prevent material accumulation. In case of material accumulation, stop the muting time limit by triggering the TR input.</p> |
| OSSDs are disabled and the protective field interrupted (red LEDs light up at the safety light barrier) and only one red LED of a muting sensor input lights up. | X | X | X | mut.sens or Error | <p>The protective field has been interrupted by an item that is shorter in length than scheduled for muting; therefore this item is detected by only one muting sensor and no override start is possible..</p> | <p>Remove the item which interrupts the protective field.</p> |
| OSSDs are disabled; several LEDs and the muting lamp flash rapidly (about 3 times / second). | X | X | X | error (number) | <p>Internal fault.</p> | <p>Perform a voltage reset on the PLSGK. If the fault message is still displayed, the PLSG must be returned to Fiesler Elektronik for repair.</p> |
| Only in selector switch mode | | | | | | |
| OSSDs are disabled | - | - | X | selector error | <p>After re-programming, the current selector switch position was not output to the PLSGK.</p> | <p>Operate the key switch which is connected to the BLPG or the BSPG.</p> |
| OSSDs are disabled | - | - | X | noOPmode assigned | <p>The selector switch setting has not been assigned to an operating mode.</p> | <p>Assign the selector switch setting to an operating mode.</p> |

| Fault | PLSG1 | PLSG2 | PLSG3 | Display PLSG3 | Possible causes | Remedies |
|---|-------|-------|-------|----------------------|--|---|
| Only in case of emergency-stop | | | | | | |
| OSSDs are disabled | - | - | X | offemerg ency err | Interruption of emergency-stop circuits too short. Emergency-stop circuit does not open. | Open and close emergency-stop for 1 s. Check emergency-stop button. |
| OSSDs are disabled | - | - | X | emergen cy error | Emergency-stop circuits are interrupted. | Check & close all such circuits. |
| Only in case of two-hand start | | | | | | |
| OSSDs are disabled | - | - | X | refresh 2hand.st | Both two-hand buttons have not been pushed within 0.5 s of each other. One of the two buttons has a defect or faulty wiring. | Activate both two-hand start buttons at the same time and release them. Check the buttons and their cabling. |
| OSSDs are disabled | - | - | | 2hand.st differ.t | Both two-hand buttons have not been released. NO contact jams. NC contact is non-conductive. | Release both two-hand buttons. Check the buttons. |
| Only with restart interlock during hazardous movement | | | | | | |
| OSSDs are disabled | - | - | X | EDMshort circuit | Downstream switching devices are turned off longer than 1 hour. Control channel (EDM) of downstream switching devices has a short-circuit after +24 V. | Actuate the start button. Check the cabling. |
| Display shows "keinGefahr!.Bew" during hazardous movement. | - | - | X | noDanger moving | Control channel (EDM) of downstream switching devices has a short-circuit after +24 V. | Check the cabling. |
| Only in cyclic mode | | | | | | |
| OSSDs are disabled | - | - | X | counter reset | Machine is stopped in the position in which the cycle reset switch is open. Cycle reset switch does not close or a line is interrupted. | Bridge the cycle reset switch. After that, perform the programmed number of interventions in the protective field and start the machine via the start button. Check the cycle reset switch. |
| Machine continuously performs successive work cycles without waiting for operator intervention. | - | - | X | | Cycle reset switch does not open. Cycle reset switch opens after a period shorter than 30 ms, or a line is short-circuited. | Check the cabling. Check the cycle reset switch or its control. Check the cabling. |
| OSSDs are disabled | - | - | X | int.rupt n.essary | Not all interventions of the protective field required for triggering machine movement have been performed yet. | Reach one more time into the protective field within the set work time monitoring time. If the work monitoring time is over, perform the number of field interruptions programmed for a release of the working movement. After that, actuate the start button within the programmed work monitoring time. |

Service

If you have any questions that cannot be answered by reading this operating manual, please contact us directly.

When calling, please have the following details ready:

- Device designation
- Serial number
- Fault symptoms and description

Fiessler Elektronik GmbH & Co. KG
Kastellstraße 9
D-73734 Esslingen

Phone +49-711-919697-0
Fax +49-711-919697-50
E-mail info@fiessler.de

Maintenance

The devices of the series of PLSG... are maintenance-free.

On request by the customer, Fiessler Elektronik GmbH & Co. KG carries out the acceptance test and annual inspections. In addition, seminars providing customers with training in annual inspections are held at regular intervals.

Warranty

The company Fiessler Elektronik GmbH & Co. KG refuses to accept any warranty claims if the device has been opened or if it has been modified.

Returning a unit

If a unit proves defective and needs to be returned, the following details will greatly help us in repairing the fault quickly:

- Exact fault description
- Has the machine furnished with the light curtain exhibited other faults?
- Have you noticed any other failures in the past?
- In which operating mode was the unit last used?

The more precise the fault description, the more efficiently and reliably we will be able to pinpoint and eliminate the fault.

Download area

The latest operating manuals, device descriptions etc. can be downloaded free-of-charge from our homepage.

<http://www.fiessler.de>

| Accessories | Title | Weight/Length | Order code |
|--|--|---------------|---------------|
| Muting sensor  | Retroreflex GR 5 / 24 T, 24 V, Transistor Output, 5 m range dark with M 12 connector, 2 m cable and reflector | 150g | GR5/24TM12DS |
| Mutingsensor  | Retroreflex GR 5 / 24 T, 24 V, transistor output, 5 m range M 12 with dark-angle plug, 2 m cable and reflector | 150g | GR5/24TM12WDS |
| Muting sensor  | Retroreflex GR 5 / 24 R, 24 V, relay output, 5 m range dark with M 12 connector, 2 m cable and reflector | 150g | GR5/24RM12DS |
| Mutingsensor  | Retroreflex GR 5 / 24 R, 24 V, relay output, 5 m range M 12 with dark-angle plug, 2 m cable and reflector | 150g | GR5/24RM12WDS |
| Mutingsensor  | Retroreflex GR 5 / 24 T, 24 V, transistor output, 5 m range light switching with M 12 connector, 2 m cable and reflector | 150g | GR5/24TM12HS |
| Muting sensor  | Retroreflex GR 5 / 24 T, 24 V, Transistor Output, 5 m range M 12 with light switching angle plug, 2 m cable and reflector | 150g | GR5/24TM12WHS |
| Muting sensor  | Retroreflex GR 5 / 24 R, 24 V, relay output, 5 m range light switching with M 12 connector, 2 m cable and reflector | 150g | GR5/24RM12HS |
| Muting sensor  | Retroreflex GR 5 / 24 R, 24 V, relay output, 5 m range M 12 with light switching angle plug, 2 m cable and reflector | 150g | GR5/24RM12WHS |
| Muting sensor  | Multifunction photocell MFL, 100x100mm incl reflector firmly attached 2m cable, with angled M12 connector. Photoelectric multifunction range to 15 meters. | 260g | MFL-M12 |
| Muting lamp  | Mutinglamp White 230V / 7W | 150g | UMLW |
| Muting lamp  | Mutinglamp White 24V / 7W | 150g | UMLW24 |
| Startup switch  | Startup switch in the mounting housing | On request | StartAufbau |
| Selector switch  | Selector switch (the switching device is required BLPG) | 80g (320g) | On request |
| M12 connectors | M12 connectors to assemble himself | 20g | On request |
| Angled M12 connector | Angled M12 connector to assemble themselves | 20g | On request |

Matching light curtains, light grids and muting sensors

Light curtains, light grids

Suitable safety light barriers can comprise, for instance, devices of the ULVT / BLVT series. These devices are available as light grids with various beam intervals.

ULVT light grid
BLVT light grid
ULVT 500/2R
LSUW 500/2
EU2K500/2
ULVT 895/3

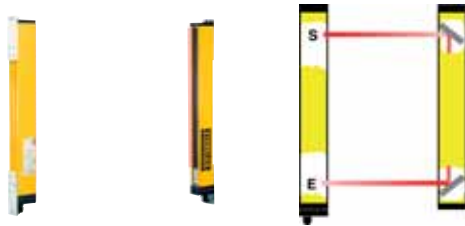

Muting sensors

Reflex light barriers or one-way light barriers can be used as muting sensors. We recommend the following reflex light barriers:

GR 5/24 with M12 plugs
MFL with M12 plugs

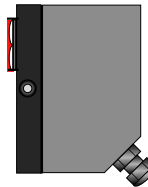
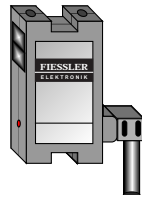

Additional safety products

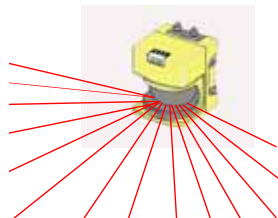

Laser scanners



Parametrizable safety controller FPSC



Press brake protection system AKAS



Light curtains for safety, control and measurement

Service

Safety seminars and integration support by our service team.

Certification

A quality management system was introduced at an early stage to guarantee the high quality of Fiessler safety equipment. Fiessler Elektronik is certified according to DIN ISO EN 9001. The company's own electromagnetic compatibility laboratory tests products on a regular basis. All safety equipment complies with national and European standards. Development takes place in consultation with the relevant trade associations. Certification is received followed rigorous tests by the Technical Inspection Board.



Recognition

by Baden Württemberg's ministry of economy of outstanding performance by the innovative AKAS safety system.



**Fiessler Elektronik
GmbH & Co. KG**
Kastellstr. 9
D-73734 Esslingen

Phone: +49(0)711 -91 96 97-0
Fax: +49(0)711-91 96 97-50
Email: info@fiessler.de
Internet: www.fiessler.de

Represented in all major countries

